



# *DSP-AX763*

---

*AV Amplifier*

OWNER'S MANUAL

## Caution: Read this before operating your unit.

- 1 To assure the finest performance, please read this manual carefully. Keep it in a safe place for future reference.
- 2 Install this sound system in a well ventilated, cool, dry, clean place – away from direct sunlight, heat sources, vibration, dust, moisture, and/or cold. Allow ventilation space of at least 30 cm on the top, 20 cm on the left and right, and 20 cm on the back of this unit.
- 3 Locate this unit away from other electrical appliances, motors, or transformers to avoid humming sounds.
- 4 Do not expose this unit to sudden temperature changes from cold to hot, and do not locate this unit in an environment with high humidity (i.e. a room with a humidifier) to prevent condensation inside this unit, which may cause an electrical shock, fire, damage to this unit, and/or personal injury.
- 5 Avoid installing this unit where foreign objects may fall onto this unit and/or this unit may be exposed to liquid dripping or splashing. On the top of this unit, do not place:
  - other components, as they may cause damage and/or discoloration on the surface of this unit.
  - burning objects (i.e. candles), as they may cause fire, damage to this unit, and/or personal injury.
  - containers with liquid in them, as they may fall and liquid may cause electrical shock to the user and/or damage to this unit.
- 6 Do not cover this unit with a newspaper, tablecloth, curtain, etc. in order not to obstruct heat radiation. If the temperature inside this unit rises, it may cause fire, damage to this unit, and/or personal injury.
- 7 Do not plug in this unit to a wall outlet until all connections are complete.
- 8 Do not operate this unit upside-down. It may overheat, possibly causing damage.
- 9 Do not use force on switches, knobs and/or cords.
- 10 When disconnecting the power cable from the wall outlet, grasp the plug; do not pull the cable.
- 11 Do not clean this unit with chemical solvents; this might damage the finish. Use a clean, dry cloth.
- 12 Only voltage specified on this unit must be used. Using this unit with a higher voltage than specified is dangerous and may cause fire, damage to this unit, and/or personal injury. Yamaha will not be held responsible for any damage resulting from use of this unit with a voltage other than specified.
- 13 To prevent damage by lightning, keep the power cord and outdoor antennas disconnected from a wall outlet or the unit during a lightning storm.
- 14 Do not attempt to modify or fix this unit. Contact qualified Yamaha service personnel when any service is needed. The cabinet should never be opened for any reasons.
- 15 When not planning to use this unit for long periods of time (i.e. vacation), disconnect the AC power plug from the wall outlet.
- 16 Install this unit near the AC outlet and where the AC power plug can be reached easily.
- 17 Be sure to read the “Troubleshooting” section on common operating errors before concluding that this unit is faulty.

18 Before moving this unit, press **Ⓢ** **STANDBY/ON** to set this unit to the standby mode, and then disconnect the AC power plug from the AC wall outlet.

19 The batteries shall not be exposed to excessive heat such as sunshine, fire or like.

20 Excessive sound pressure from earphones and headphones can cause hearing loss.

### WARNING

TO REDUCE THE RISK OF FIRE OR ELECTRIC SHOCK, DO NOT EXPOSE THIS UNIT TO RAIN OR MOISTURE.

As long as this unit is connected to the AC wall outlet, it is not disconnected from the AC power source even if you turn off this unit by **Ⓢ** **STANDBY/ON**. In this state, this unit is designed to consume a very small quantity of power.

### ■ For U.K. customers

If the socket outlets in the home are not suitable for the plug supplied with this appliance, it should be cut off and an appropriate 3 pin plug fitted. For details, refer to the instructions described below.

### Note

The plug severed from the mains lead must be destroyed, as a plug with bared flexible cord is hazardous if engaged in a live socket outlet.

### ■ Special Instructions for U.K. Model

#### IMPORTANT

THE WIRES IN MAINS LEAD ARE COLOURED IN ACCORDANCE WITH THE FOLLOWING CODE:

Blue: NEUTRAL

Brown: LIVE

As the colours of the wires in the mains lead of this apparatus may not correspond with the coloured markings identifying the terminals in your plug, proceed as follows:

The wire which is coloured BLUE must be connected to the terminal which is marked with the letter N or coloured BLACK. The wire which is coloured BROWN must be connected to the terminal which is marked with the letter L or coloured RED.

Making sure that neither core is connected to the earth terminal of the three pin plug.



This symbol mark is according to the EU directive 2002/96/EC.

This symbol mark means that electrical and electronic equipment, at their end-of-life, should be disposed of separately from your household waste.

Please act according to your local rules and do not dispose of your old products with your normal household waste.

# Contents

## INTRODUCTION

<b>Features</b> .....	2
Supplied accessories .....	2
<b>Notice</b> .....	3
<b>Getting started</b> .....	4
<b>Quick start guide</b> .....	5

## PREPARATION

<b>Connections</b> .....	10
<b>Optimizing the speaker setting for your listening room (YPAO)</b> .....	31
Using AUTO SETUP .....	31

## BASIC OPERATION

<b>Selecting the SCENE templates</b> .....	36
Selecting the desired SCENE template to the SCENE buttons.....	36
Creating your original SCENE templates.....	39
Using the remote control for the SCENE feature ....	40
<b>Playback</b> .....	41
Basic procedure .....	41
Selecting the MULTI CH INPUT component.....	42
Selecting the front speaker set .....	42
Selecting audio input jacks (AUDIO SELECT).....	43
Displaying the current status of this unit on a video monitor.....	43
Using your headphones.....	44
Muting the audio output.....	44
Playing video sources in the background of an audio source.....	44
Displaying the input source information .....	45
Using the sleep timer .....	46
<b>Sound field programs</b> .....	47
Selecting sound field programs .....	47
Sound field program descriptions.....	47
Enjoying unprocessed input sources (Straight decoding mode) .....	50
<b>Using audio features</b> .....	51
Adjusting the speaker level.....	51
Enjoying pure hi-fi sound .....	51
Adjusting the tonal quality.....	51
<b>Using iPod™</b> .....	52
Controlling iPod™.....	52
<b>Using Bluetooth™ components</b> .....	54
Pairing the Bluetooth™ adapter and your Bluetooth™ component .....	54
Playback of the Bluetooth™ component.....	54
<b>Recording</b> .....	55

## ADVANCED OPERATION

<b>Advanced sound configurations</b> .....	56
Changing sound field parameter settings.....	56
Selecting decoders .....	61
<b>Customizing this unit (MANUAL SETUP)</b> .....	63
Using SET MENU .....	67
1 BASIC MENU .....	68
2 VOLUME MENU .....	72
3 SOUND MENU.....	73
4 INPUT MENU.....	76
5 OPTION MENU.....	79
<b>Remote control features</b> .....	82
Controlling this unit, a TV, or other components....	82
Setting remote control codes .....	84
Programming codes from other remote controls ....	86
Changing source names in the display window.....	87
Macro programming features .....	88
Clearing configurations .....	91
<b>Advanced setup</b> .....	94
Using the advanced setup .....	94

## ADDITIONAL INFORMATION

<b>Troubleshooting</b> .....	97
<b>Resetting the system</b> .....	104
<b>Glossary</b> .....	105
<b>Sound field program information</b> .....	108
<b>Specifications</b> .....	109
<b>Index</b> .....	110

## APPENDIX

(at the end of this manual)

<b>Front panel</b> .....	i
<b>Remote control</b> .....	ii
<b>List of remote control codes</b> .....	iii

“(A) SPEAKERS” or “(5) DVD” (example) indicates the name of the parts on the front panel or the remote control. Refer to the attached sheet or the pages at the end of this manual for the information about each position of the parts.

# Features

## Built-in 7-channel power amplifier

- ◆ Minimum RMS output power (20 Hz to 20 kHz, 0.06% THD, 8 Ω)  
Front: 95 W + 95 W  
Center: 95 W  
Surround: 95 W + 95 W  
Surround back: 95 W + 95 W

## SCENE function

- ◆ Preset SCENE templates for various situations
- ◆ SCENE templates for customizing capability
- ◆ Controlling Yamaha SCENE control signal support component (some models only) working with the SCENE function

## Sound field programs

- ◆ Proprietary Yamaha technology for the creation of sound fields
- ◆ Compressed Music Enhancer mode
- ◆ Virtual CINEMA DSP
- ◆ SILENT CINEMA

## Digital audio decoders

- ◆ Dolby TrueHD, Dolby Digital Plus decoder
- ◆ DTS-HD Master Audio, DTS-HD High Resolution Audio decoder
- ◆ Dolby Digital/Dolby Digital EX decoder
- ◆ DTS/DTS-ES Matrix 6.1, Discrete 6.1, DTS 96/24 decoder
- ◆ Dolby Pro Logic/Dolby Pro Logic II/Dolby Pro Logic IIX decoder

## HDMI™ (High-Definition Multimedia Interface)

- ◆ HDMI interface for standard, enhanced or high-definition video as well as multi-channel digital audio based on HDMI version 1.3a (HDMI is licensed by HDMI Licensing LLC.)
  - Automatic audio and video synchronization (lip sync) information capability
  - Deep Color video signal (30/36 bit) transmission capability
  - “x.v.Color” video signal transmission capability
  - High refresh rate and high resolution video signals capability
  - High definition digital audio format signals capability
- ◆ HDCP (High-bandwidth Digital Content Protection System) licensed by Digital Content Protection, LLC.
- ◆ Analog video to HDMI digital video up-conversion (composite video ↔ S-video ↔ component video → HDMI digital video) capability for monitor out

## DOCK terminal

- ◆ DOCK terminal to connect a Yamaha iPod universal dock (such as YDS-10, sold separately) or Bluetooth adapter (such as YBA-10, sold separately)

## Other features

- ◆ YPAO (Yamaha Parametric Room Acoustic Optimizer) for automatic speaker setup
- ◆ 192-kHz/24-bit D/A converter
- ◆ OSD (on-screen display) menus that allow you to optimize this unit to suit your individual audiovisual system
- ◆ 5.1 or 7.1-channel additional input jacks for discrete multi-channel input
- ◆ Component video input/output capability includes (3 COMPONENT VIDEO INs and 1 MONITOR OUT)
- ◆ Digital video signal conversion (composite video ↔ S-video ↔ component video) capability for monitor out
- ◆ Pure Direct mode for pure hi-fi sound for all sources
- ◆ Adaptive dynamic range controlling capability
- ◆ Adaptive DSP effect level controlling capability
- ◆ iPod controlling capability
- ◆ Remote control with preset remote control codes, learning, and macro capability
- ◆ Bi-amplification connection capability
- ◆ Sleep timer



## Supplied accessories

Check that you received all of the following parts.

- Remote control
- Batteries (4) (AAA, R03, UM-4)
- Optimizer microphone

# Notice

## About this manual

-  indicates a tip for your operation.
- Some operations can be performed by using either the buttons on the front panel or the ones on the remote control. In case the button names differ between the front panel and the remote control, the button name on the remote control is given in parentheses.
- This manual is printed prior to production. Design and specifications are subject to change in part as a result of improvements, etc. In case of differences between the manual and product, the product has priority.
- “**SPEAKERS**” or “**DVD**” (example) indicates the name of the parts on the front panel or the remote control. Refer to the attached sheet or the pages at the end of this manual for the information about each position of the parts.
- The symbol “” with page number(s) indicates the corresponding reference page(s).



Manufactured under license from Dolby Laboratories. “Dolby”, “Pro Logic”, and the double-D symbol are trademarks of Dolby Laboratories.



Manufactured under license under U.S. Patent No's: 5,451,942;5,956,674;5,974,380;5,978,762;6,226,616;6,487,535 & other U.S. and worldwide patents issued & pending. DTS is a registered trademark and the DTS logos, Symbol, DTS-HD and DTS-HD Master Audio are trademark of DTS, Inc. © 1996-2007 DTS, Inc. All Rights Reserved.

## iPod™

“iPod” is a trademark of Apple Inc., registered in the U.S. and other countries.

## Bluetooth™

Bluetooth is a registered trademark of the Bluetooth SIG and is used by Yamaha in accordance with a license agreement.

# HDMI

“HDMI”, the “HDMI” logo and “High-Definition Multimedia Interface” are trademarks or registered trademarks of HDMI Licensing LLC.

## x.v.Color™

“x.v.Color” is a trademark of Sony Corporation.

## SILENT™ CINEMA

“SILENT CINEMA” is a trademark of Yamaha Corporation.

# Getting started

## ■ Installing batteries in the remote control

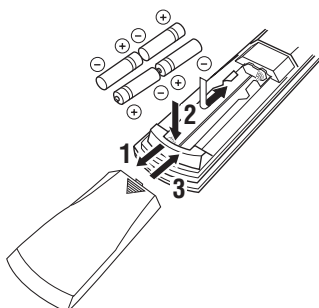

**1** Press the ▼ part and slide the battery compartment cover off.

**2** Insert the four supplied batteries (AAA, R03, UM-4) according to the polarity markings (+ and –) on the inside of the battery compartment.

**3** Slide the cover back until it snaps into place.

### Notes

- Change all of the batteries if you notice the following conditions:
  - the operation range of the remote control decreases.
  - the transmit indicator (②) does not flash or its light becomes dim.
- Do not use an old battery together with a new one.
- Do not use different types of batteries (such as alkaline and manganese batteries) together. Read the packaging carefully as these different types of batteries may have the same shape and color.
- If the batteries have leaked, dispose of them immediately. Avoid touching the leaked material or letting it come into contact with clothing, etc. Clean the battery compartment thoroughly before installing new batteries.
- Do not throw away batteries with general house waste; dispose of them correctly in accordance with your local regulations.
- If the remote control is without batteries for more than 2 minutes, or if exhausted batteries remain in the remote control, the contents of the memory may be cleared. When the memory is cleared, insert new batteries, set up the remote control code and program any acquired functions that may have been cleared.

# Quick start guide

The following steps describe the easiest way to enjoy DVD movie playback in your home theater. See pages 11 to 15 for details of the speaker placement.

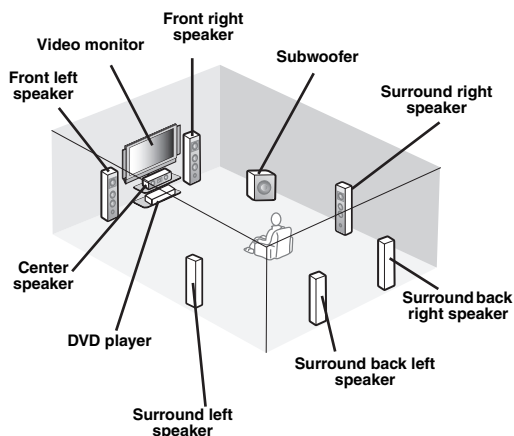

## Step 1: Set up your speakers

P. 6

## Step 2: Connect your DVD player and other components

P. 7

## Step 3: Press SCENE 1 button

P. 8

**Enjoy DVD playback!**

## Preparation: Check the items

Prepare the following items.

- Speakers**
  - Front speakers** ..... x 2
  - Center speaker** ..... x 1
  - Surround speakers** ..... x 4Select magnetically shielded speakers. The minimum required speakers are two front speakers. The priority of the requirement of other speakers is as follows:
  1. Two surround speakers
  2. Center speaker
  3. One (or two) surround back speaker(s)
- Active subwoofer** ..... x 1  
Select an active subwoofer equipped with an RCA input jack.
- Speaker cables** ..... x 7
- Subwoofer cable** ..... x 1  
Select a monaural RCA cable.
- DVD player** ..... x 1  
Select DVD player equipped with coaxial digital audio output jack and composite video output jack.
- Video monitor** ..... x 1  
Select a TV monitor, video monitor or projector equipped with a composite video input jack.
- Video cable** ..... x 2  
Select an RCA composite video cable.
- Digital coaxial audio cable** ..... x 1



You can also connect two subwoofers to this unit. In this case, prepare two active subwoofers and subwoofer cables.

## Step 1: Set up your speakers

Place your speakers in the room and connect them to this unit.

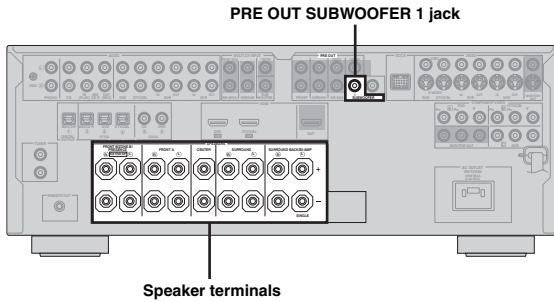

**1** Place your speakers and subwoofer in the room.

**2** Connect speaker cables to each speaker.

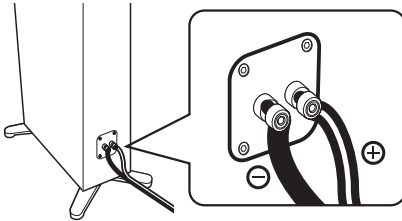

Be sure to connect the “+” (red) and “-” (black) properly. Cables are colored or shaped differently, perhaps with a stripe, groove or ridge. Connect the striped (grooved, etc.) cable to the “+” (red) terminals of this unit and your speaker. Connect the plain cable to the “-” (black) terminals.

**3** Connect each speaker cable to the corresponding speaker terminal of this unit.

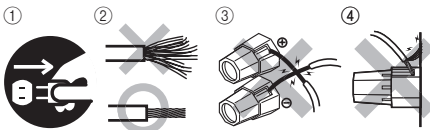

- ① Make sure that this unit and the subwoofer are unplugged from the AC wall outlets.
- ② Twist the exposed wires of the speaker cables together to prevent short circuits.
- ③ Do not let the bare speaker wires touch each other.
- ④ Do not let the bare speaker wires touch any metal part of this unit.

Be sure to connect the left channel (L), right channel (R), “+” (red) and “-” (black) properly.

### Front speakers and center speaker

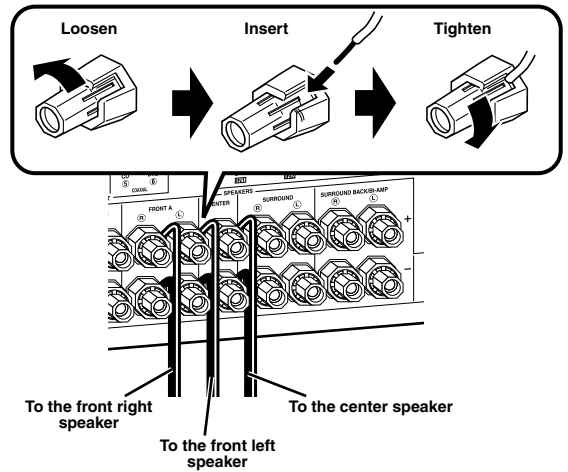

### Surround and surround back speakers

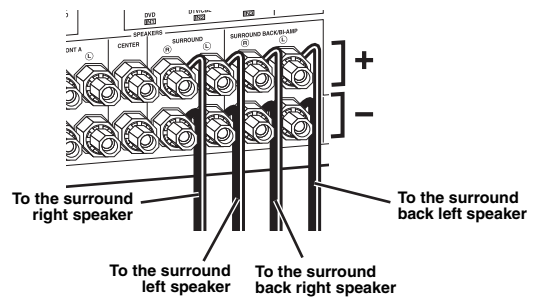

**4** Connect the subwoofer cable to the SUBWOOFER PRE OUT 1 jack of this unit and the input jack of the subwoofer.

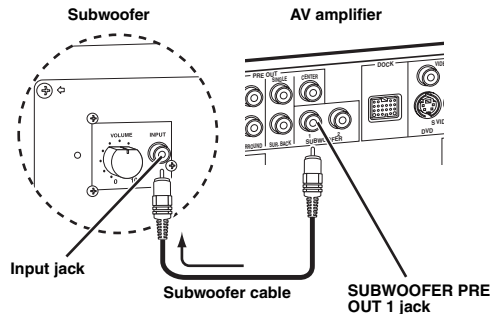

You can also connect another subwoofer to the SUBWOOFER PRE OUT 2 jack.



## Step 2: Connect your DVD player and other components

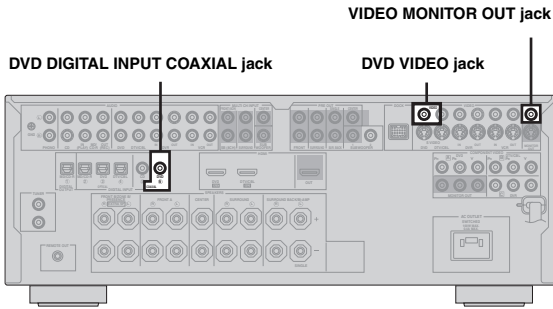

Make sure that this unit and the DVD player are unplugged from the AC wall outlets.

- 1 Connect the digital coaxial audio cable to the digital coaxial audio output jack of your DVD player and the DVD DIGITAL INPUT COAXIAL jack of this unit.

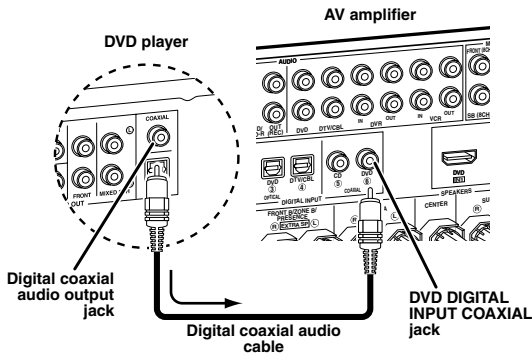

- 2 Connect the video cable to the composite video output jack of your DVD player and DVD VIDEO jack of this unit.

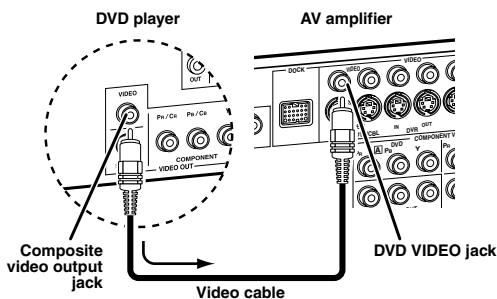

- When you connect a component that has only a SCART jack, use an appropriate converter. The connection between a converter and this unit depends on signals that are available on the converter. For details, refer to the instructions of your converter.
- This unit cannot transmit RGB signals.

- 3 Connect the video cable to the VIDEO MONITOR OUT jack of this unit and the video input jack of your video monitor.

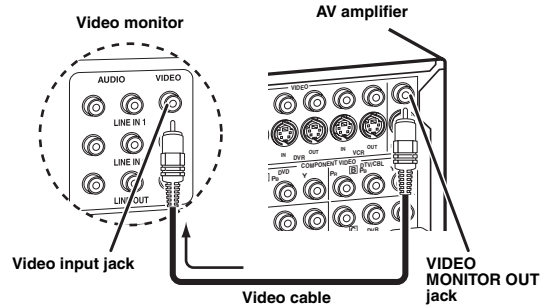

- 4 Connect the power plug of this unit and other components into the AC wall outlet.



This unit is equipped with AC OUTLET for the power supply of the other components. See page 27 for details.

### ■ For further connections

- Using the other kind of speaker combinations P. 11
- Connecting a video monitor via various ways of the connection P. 20
- Connecting a DVD player via various ways of the connection P. 21
- Connecting a DVD recorder or a digital video recorder P. 22
- Connecting a set-top box P. 22
- Connecting a CD player, an MD recorder, tuner, or a turntable P. 23
- Connecting an external amplifier P. 24
- Connecting a DVD player via analog multi-channel audio connection P. 25
- Connecting a Yamaha iPod universal dock or Bluetooth adapter P. 25
- Using the REMOTE OUT jack P. 26
- Using the VIDEO AUX jacks on the front panel P. 26

## Step 3: Press SCENE 1 button

### Check the type of the connected speakers.

If the speakers are 6 ohm speakers, set "SP IMP." to "6ΩMIN" before using this unit (see page 27). 4 ohm speakers can be also used as the front speakers (see page 94).

**1 Turn on the video monitor and then set the input source selector of the video monitor to this unit.**

**2 Press  SCENE 1 button.**

This unit is turned on. "DVD Movie Viewing" appears in the front panel display, and this unit automatically optimize own status for the DVD playback.

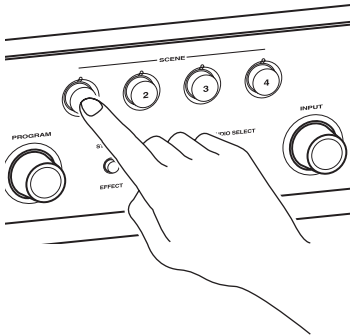

The indicator on the selected SCENE button lights up while this unit is in the SCENE mode.

**3 Rotate  VOLUME to adjust the volume.**

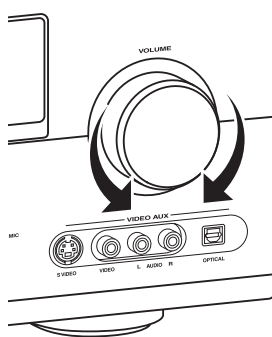

### Note

When you change the input source or sound field program, the SCENE mode is deactivated.

## About SCENE function

Just by pressing one SCENE button, you can turn on this unit and recall your favorite input source and sound field program according to the SCENE template that has been assigned to the SCENE button. The SCENE templates are built combinations of input sources and sound field programs.



If you connect a Yamaha product that has capability of the SCENE control signals, this unit can automatically activate the component and start playback. Refer to the instruction manual of the DVD player for further information.

## The default assigned SCENE templates

Default SCENE button	The name of the SCENE template and its description
<b>SCENE 1</b>	<b>DVD Movie Viewing</b> – input source: DVD – sound field program: Sci-Fi For when you want to enjoy a movie from the connected DVD player.
<b>SCENE 2</b>	<b>Music Disc Listening</b> – input source: DVD – sound field program: 2ch Stereo For when you want to listen to a music disc from the connected DVD player.
<b>SCENE 3</b>	<b>TV Viewing</b> *1 – input source: DTV/CBL – sound field program: Straight For when you want to watch a TV program.
<b>SCENE 4</b>	<b>Radio Listening</b> *2 – input source: TUNER – sound field program: 7ch Enhancer For when you want to listen to a music program of the FM/AM/DAB radio station.

## Notes

\*1 You must connect a cable TV or a satellite tuner to this unit in advance. See page 22 for details.

\*2 You must connect an FM/AM/DAB tuner to this unit in advance. See page 23 for details.



You can change the assigned SCENE template for the SCENE buttons. See page 36 for details.

## ■ After using this unit...

Press **Ⓢ** **STANDBY/ON** to set this unit to the standby mode.

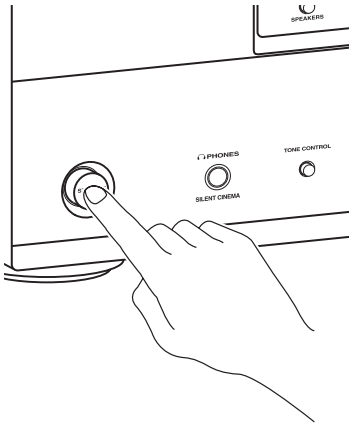

This unit is set to the standby mode and consumes a small amount of power in order to receive infrared signals from the remote control. To turn on this unit from the standby mode, press the desired **Ⓢ** **SCENE** buttons (or **Ⓢ** **SCENE**) or **Ⓢ** **STANDBY/ON** (or **Ⓢ** **POWER**). See page 28 for details.

## What do you want to do with this unit?

### ■ Customizing the SCENE templates

- Using various SCENE templates [P. 36](#)
- Creating your original SCENE templates [P. 39](#)

### ■ Using various input sources

- Basic controls of this unit [P. 41](#)
- Using your iPod with this unit [P. 52](#)
- Using the Bluetooth components [P. 54](#)

### ■ Using various sound features

- Using various sound field programs [P. 47](#)
- Using the pure direct mode for high fidelity sound [P. 51](#)
- Customizing the sound field programs [P. 56](#)

### ■ Adjusting the parameters of this unit

- Automatically optimizing the speaker parameters for your listening room (AUTO SETUP) [P. 31](#)
- Manually adjusting various parameters of this unit [P. 63](#)
- Setting the remote control [P. 82](#)
- Adjusting the advanced parameters [P. 94](#)

### ■ Additional feature

- Automatically turning off this unit [P. 46](#)



## Placing speakers

The speaker layout below shows the speaker setting we recommend. You can use it to enjoy the CINEMA DSP and multi-channel audio sources.

### 7.1-channel speaker layout

7.1-channel speaker layout is highly recommended for playback the sound of high definition audio formats (Dolby TrueHD, DTS-HD Master Audio, etc.) as well as the conventional audio sources with sound field programs. See page 14 for connection information.

 We recommend that you also add the presence speakers for the effect sounds of the CINEMA DSP sound field program. See page 13 for details.

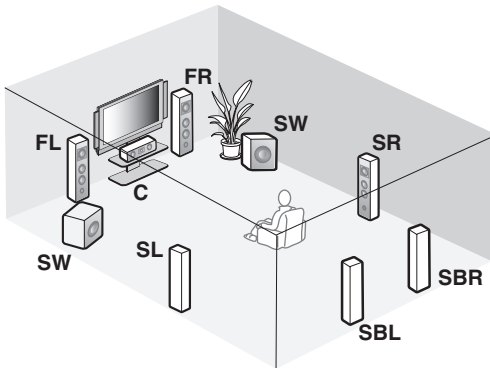

#### Speaker indications

**FL/FR:** Front left/right

**C:** Center

**SL/SR:** Surround left/right

**SBL/SBR:** Surround back left/right

**SW:** Subwoofer

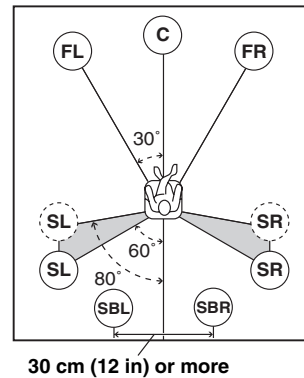

#### Front left and right speakers

The front speakers are used for the main source sound plus effect sounds. Place these speakers at an equal distance from the ideal listening position. The distance of each speaker from each side of the video monitor should be the same.

#### Center speaker

The center speaker is for the center channel sounds (dialog, vocals, etc.). If for some reason it is not practical to use a center speaker, you can do without it. Best results, however, are obtained with the full system.

#### Surround left and right speakers

The surround speakers are used for effect and surround sounds.

#### Surround back left and right speakers

The surround back speakers supplement the surround speakers and provide more realistic front-to-back transitions.

#### Subwoofer(s)

The use of a subwoofer with a built-in amplifier, such as the Yamaha Active Servo Processing Subwoofer System, is effective not only for reinforcing bass frequencies from any or all channels, but also for reproducing the high fidelity sound of the LFE (low-frequency effect) channel included in Dolby Digital and DTS sources. You can connect one or two subwoofer(s) to this unit. When you use two subwoofers, you can enjoy deeper bass sound. The position of the subwoofer is not so critical, because low bass sounds are not highly directional. But it is better to place the subwoofer near the front speakers. Turn it slightly toward the center of the room to reduce wall reflections.

 When you use two subwoofers, select the same type of the subwoofer as another and set these subwoofers as same sound characteristics. Place each subwoofer at the same distance from the listening position. The signal output at the SUBWOOFER PRE OUT 2 jack is the same as the one output at the SUBWOOFER PRE OUT 1 jack.

### ■ 6.1-channel speaker layout

See page 14 for connection information.



We recommend that you also add the presence speakers for the effect sounds of the CINEMA DSP sound field program. See page 13 for details.

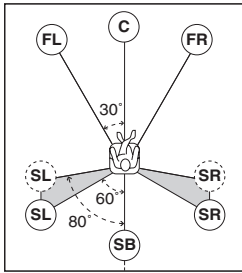
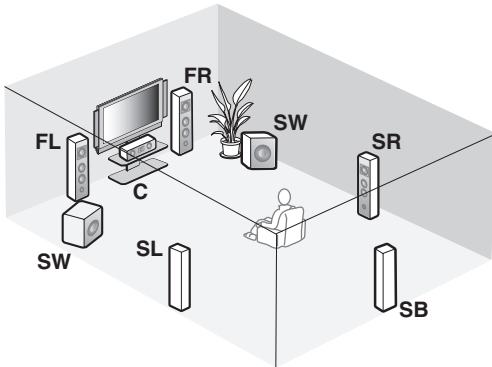

#### Speaker indications

- FL/FR:** Front left/right
- C:** Center
- SL/SR:** Surround left/right
- SB:** Surround back
- SW:** Subwoofer

### ■ 5.1-channel speaker layout

See page 14 for connection information.



We recommend that you also add the presence speakers for the effect sounds of the CINEMA DSP sound field program. See page 13 for details.

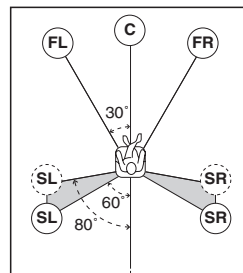
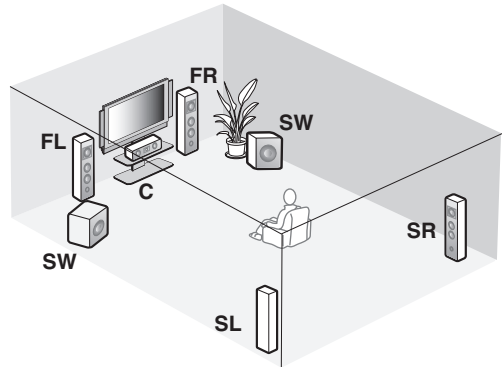

#### Speaker indications

- FL/FR:** Front left/right
- C:** Center
- SL/SR:** Surround left/right
- SW:** Subwoofer

#### Front left and right speakers

#### Center speaker

#### Surround left and right speakers

#### Subwoofer(s)

The functions and settings of each speaker are the same as those for the 7.1-channel speaker layout (see page 11).

#### Surround back speaker

Connect a single surround speakers to the SURROUND BACK SINGLE speaker terminal and place the single surround back speaker behind the listening position. The surround back left and right channel signals are mixed down and output at the single surround back speaker when you set "SUR.B L/R SP" to "SMLx1" or "LRGx1" (see page 69).

#### Front left and right speakers

#### Center speaker

#### Subwoofer(s)

The functions and settings of each speaker are the same as those for the 7.1-channel speaker layout (see page 11).

#### Surround left and right speakers

Connect the surround speakers to the SURROUND speaker terminals even if you place the surround speakers behind the listening position. For the smooth and unbroken sound field behind the listening position, place the surround left and right speakers farther back compared with the placement in the 7.1-channel speaker layout. The surround back channel signals are directed to the surround left and right speakers when "SUR.B L/R SP" is set to "NONE" (see page 69).

#### For other speaker combinations

You can enjoy multi-channel sources with sound field programs by using a speaker combination other than the 7.1/6.1/5.1-channel speaker combinations.

Use the automatic setup feature (see page 31) or set the "SPEAKER SET" parameters in "MANUAL SETUP" (see page 68) to output the surround sounds at the connected speakers.

## ■ Using presence speakers

The presence speakers supplement the sound from the front and surround back speakers with extra ambient effects produced by the sound field programs (see page 47). You can adjust the vertical position of dialogues with using the presence speakers (see page 57).

To use the presence speakers, connect the speakers to the EXTRA SP terminal (see page 14) and set “EXTRA SP ASSIGN” to “PRESENCE” (see pages 32 and 68).

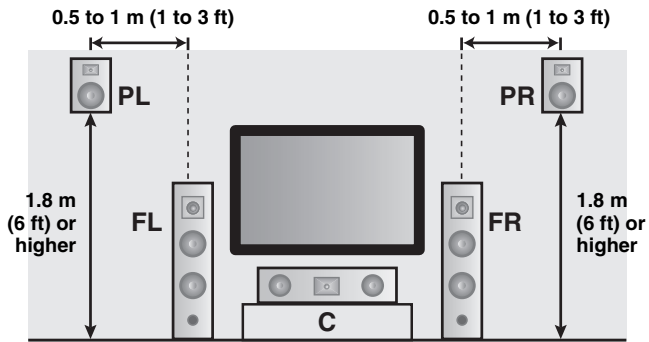

### Speaker indications

- FL:** Front left
- FR:** Front right
- C:** Center
- PL:** Front presence left
- PR:** Front presence right

## Connecting speakers

Be sure to connect the left channel (L), right channel (R), “+” (red) and “-” (black) properly. If the connections are faulty, this unit cannot reproduce the input sources accurately.

### Caution

- Before connecting the speakers, make sure that the AC power plug is disconnected from the AC wall outlet.
- Do not let the bare speaker wires touch each other or let them touch any metal part of this unit. This could damage this unit and/or the speakers. If the speaker wires are short-circuited, “CHECK SP WIRES” appears in the front panel display when you turn on this unit.
- Use the magnetically shielded speakers. If this type of speaker still creates interference with the monitor, place the speakers away from the monitor.
- If you are to use 6 ohm speakers, be sure to set “SP IMP.” to “6ΩMIN” before using this unit (see page 27). 4 ohm speakers can be also used as the front speakers. For details about the speaker impedance setting, see page 94.

### Note

A speaker cord is actually a pair of insulated cables running side by side. Cables are colored or shaped differently, perhaps with a stripe, groove or ridge. Connect the striped (grooved, etc.) cable to the “+” (red) terminals of this unit and your speaker. Connect the plain cable to the “-” (black) terminals.

### ■ For the 7.1-channel speaker setting

#### EXTRA SP terminals

Connect the alternative front speaker system (FRONT B), front speaker systems in another room (ZONE B), or presence speakers. To select the function of the speakers connected to the EXTRA SP terminals, set the “EXTRA SP ASSIGN” parameter in “SOUND MENU” (see page 68).



You can also select the function of the speakers connected to the EXTRA SP terminals in “AUTO SETUP” (see page 32).

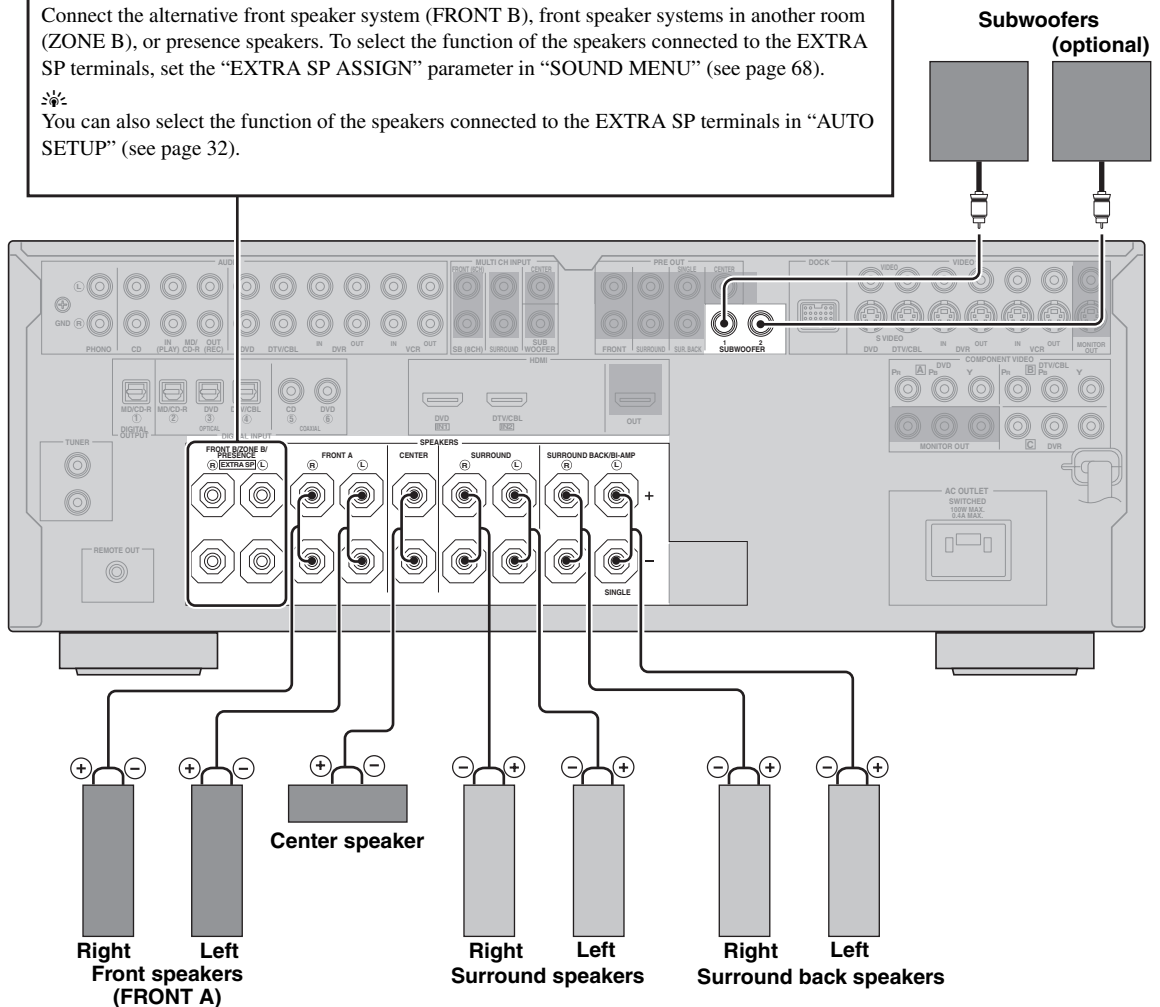



■ For the 6.1-channel speaker setting

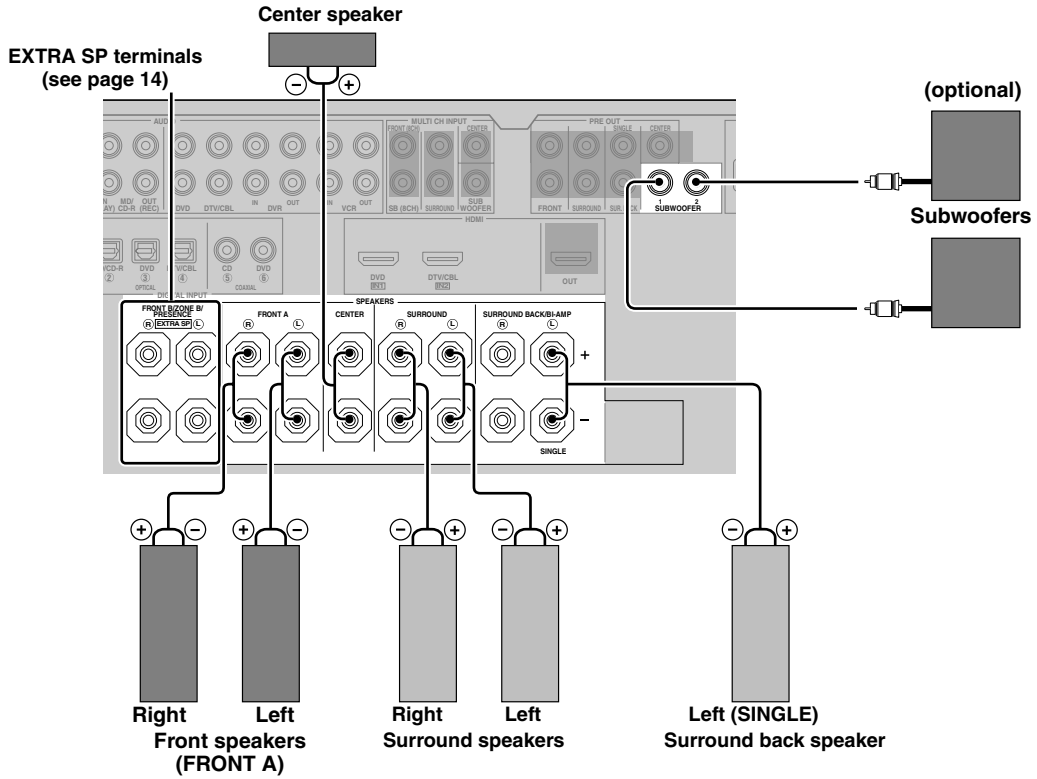

■ For the 5.1-channel speaker setting

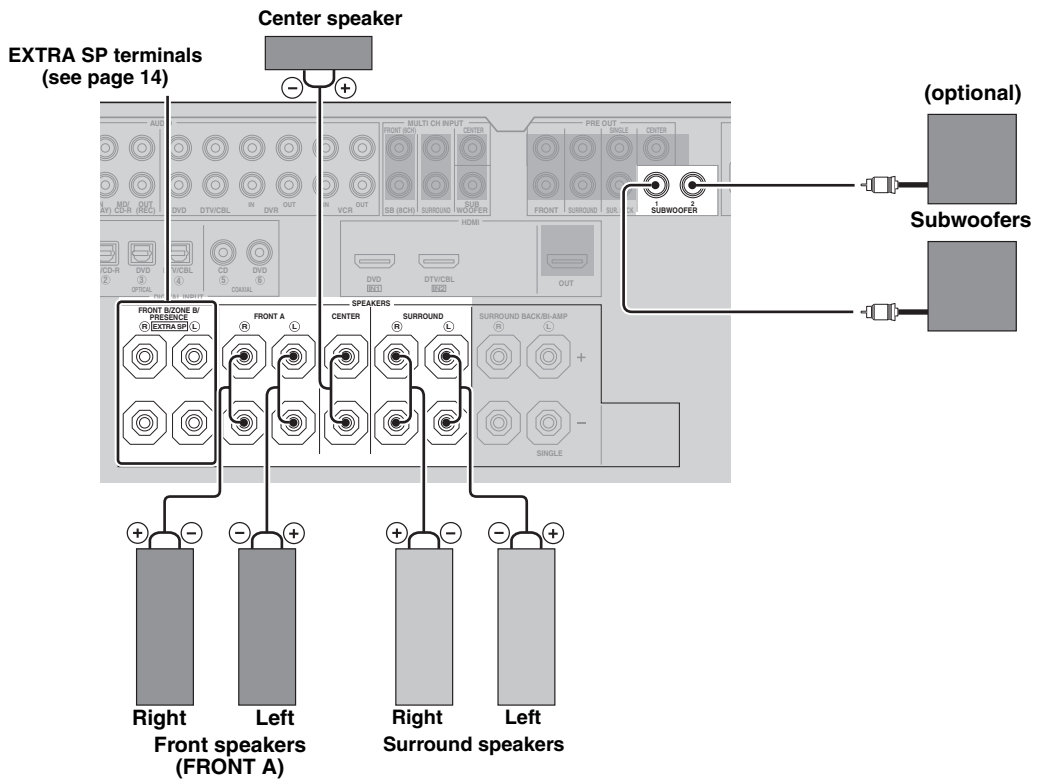

■ Connecting the speaker cable

- 1 Remove approximately 10 mm of insulation from the end of each speaker cable and then twist the exposed wires of the cable together to prevent short circuits.

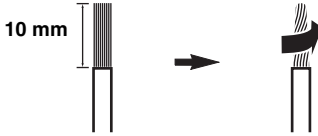

- 2 Loosen the knob.

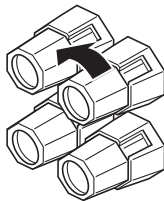

Red: positive (+)  
Black: negative (-)

- 3 Insert one bare wire into the hole on the side of each terminal.

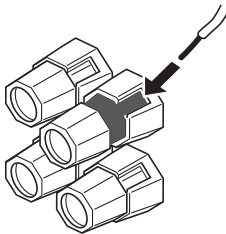

- 4 Tighten the knob to secure the wire.

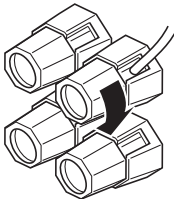

■ Using bi-amplification connections

**Caution**

Remove the shorting bars or bridges of your speakers to separate the LPF (low pass filter) and HPF (high pass filter) crossovers.

This unit allows you to make bi-amplification connections to one speaker system. Check if your speakers support bi-amplification.

To make the bi-amplification connections, use the FRONT and SURROUND BACK/BI-AMP terminals as shown below. To activate the bi-amplification connections, set “BI-AMP” to “ON” in “ADVANCED SETUP” (see page 96).

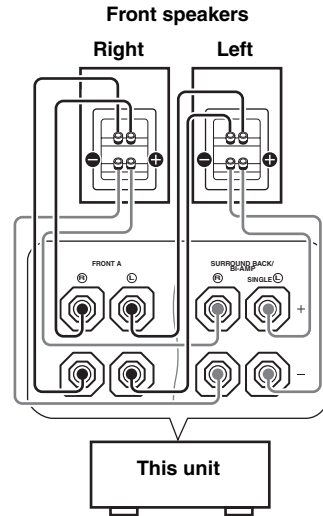

**Note**

When you make the conventional connection, make sure that the shorting bars are put into the terminals appropriately. Refer to the instruction manuals of the speakers for details.

## Information on jacks and cable plugs

Connect one of the type of the audio jack(s) and/or video jack(s) that your input components are equipped with.

### Audio jacks and cable plugs

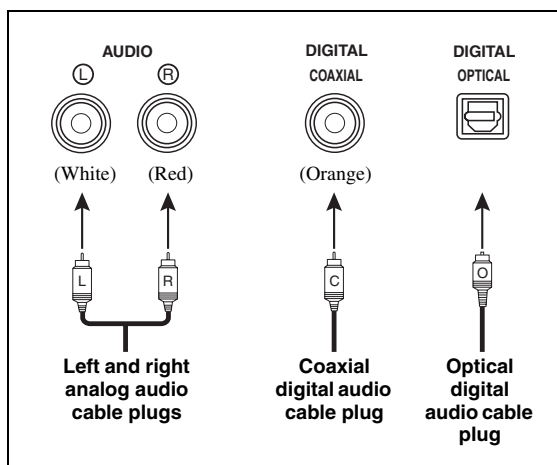

#### ■ Audio jacks

This unit has three types of audio jacks. Connection depends on the availability of audio jacks on your other components.

##### AUDIO jacks

For conventional analog audio signals transmitted via left and right analog audio cables. Connect red plugs to the right jacks and white plugs to the left jacks.

##### DIGITAL COAXIAL jacks

For digital audio signals transmitted via coaxial digital audio cables.

##### DIGITAL OPTICAL jacks

For digital audio signals transmitted via optical digital audio cables.

#### Note

You can use the digital jacks to input PCM, Dolby Digital and DTS bitstreams. When you connect components to both the COAXIAL and OPTICAL jacks, priority is given to the signals input at the COAXIAL jack. Optical input jacks are compatible with digital signals with up to 96 kHz of sampling frequency.

### Video jacks and cable plugs

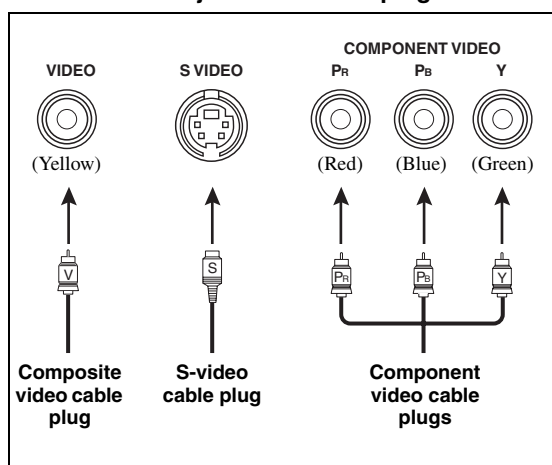

#### ■ Video jacks

This unit has three types of video jacks. Connection depends on the availability of input jacks on your video monitor.

##### VIDEO jacks

For conventional composite video signals transmitted via composite video cables.

##### S VIDEO jacks

For S-video signals, separated into the luminance (Y) and chrominance (C) video signals transmitted on separate wires of S-video cables.

##### COMPONENT VIDEO jacks

For component video signals, separated into the luminance (Y) and chrominance (P<sub>B</sub>, P<sub>R</sub>) video signals transmitted on separate wires of component video cables.



This unit is equipped with the video conversion function. See pages 19 and 80 for details.

## Information on HDMI™

### ■ HDMI signal compatibility

#### Audio signals

Audio signal types	Audio signal formats	Compatible media
2ch Linear PCM	2ch, 32-192 kHz, 16/20/24 bit	CD, DVD-Video, DVD-Audio, etc.
Multi-ch Linear PCM	8ch, 32-192 kHz, 16/20/24 bit	DVD-Audio, Blu-ray Disc, HD DVD, etc.
DSD	2/5.1ch, 2.8224 MHz, 1 bit	SA-CD, etc.
Bitstream	Dolby Digital, DTS	DVD-Video, etc.
Bitstream (High definition audio)	Dolby TrueHD, Dolby Digital Plus, DTS-HD Master Audio, DTS-HD High Resolution Audio, DTS Express	Blu-ray Disc, HD DVD, etc.



- If the input source component can decode the bitstream audio signals of audio commentaries, you can play back the audio sources with the audio commentaries mixed down by using the following connections:
  - multi-channel analog audio input (see page 25)
  - DIGITAL INPUT OPTICAL (or COAXIAL)
- Refer to the supplied instruction manuals of the input source component, and set the component appropriately.

#### Notes

- When CPPM copy-protected DVD-Audio is played back, video and audio signals may not be output depending on the type of the DVD player.
- This unit is not compatible with HDCP-incompatible HDMI or DVI components.
- To decode audio bitstream signals on this unit, set the input source component appropriately so that the component outputs the bitstream audio signals directly (does not decode the bitstream signals on the component). Refer to the supplied instruction manuals for details.
- This unit is not compatible with the audio commentary features (for example, the special audio contents downloaded via Internet) of Blu-ray Disc or HD DVD. This unit does not play back the audio commentaries of the Blu-ray Disc or HD DVD contents.

### Video signals

This unit is compatible with the video signals of the following resolutions:

#### Video signal format

- 480i/60 Hz
- 576i/50 Hz
- 480p/60 Hz
- 576p/50 Hz
- 720p/60 Hz, 50 Hz
- 1080i/60 Hz, 50 Hz
- 1080p/60 Hz, 50 Hz, 24 Hz

#### Default input assignment of HDMI input jacks

HDMI input jack	Assigned input source
IN1	DVD
IN2	DTV/CBL

### ■ HDMI jack and cable plug

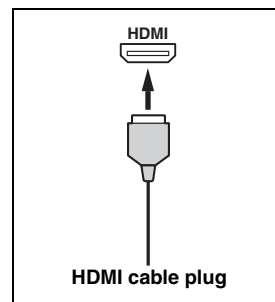

- We recommend that you use an HDMI cable shorter than 5 meters (16 feet) with the HDMI logo printed on it.
- Use a conversion cable (HDMI jack ↔ DVI-D jack) to connect this unit to other DVI components.

#### Notes

- Do not disconnect or connect the cable or turn off the power of the HDMI components connected to the HDMI OUT jack of this unit while data is being transferred. Doing so may disrupt playback or cause noise.
- If you turn off the power of the video monitor connected to the HDMI OUT jack via a DVI connection, this unit may fail to establish the connection to the component.
- The analog video signals input at the composite video, S-video and component video jacks can be digitally up-converted to be output at the HDMI OUT jack. Set "VIDEO CONV." to "ON" in "MANUAL SETUP" (see page 80) to activate this feature.

## Audio and video signal flow

### Audio signal flow

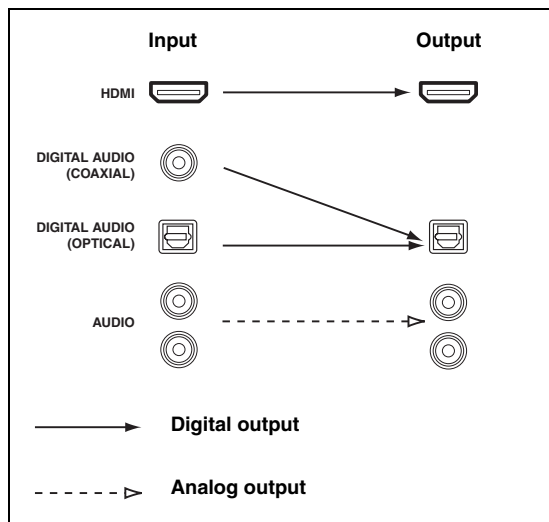

#### Notes

- 2-channel as well as multi-channel PCM, Dolby Digital and DTS signals input at one of the HDMI IN jacks can be output at the HDMI OUT jack only when "S.AUDIO" is set to "OTHER" (see page 81).
- Audio signals input at the HDMI IN jacks are not output at the AUDIO output and DIGITAL OUTPUT jacks.

### Video signal flow

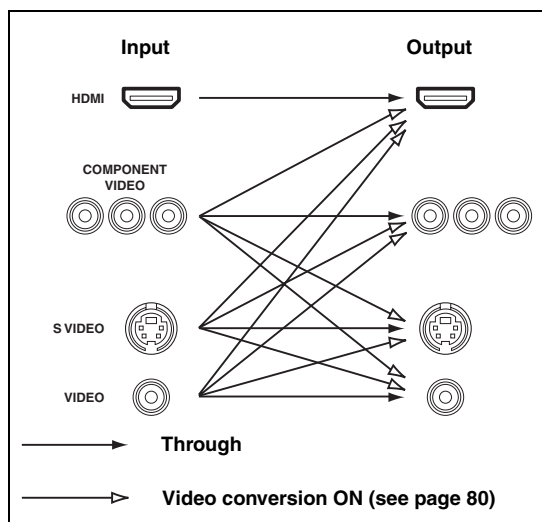

#### Notes

- When the video signals are input at the HDMI, COMPONENT VIDEO, S VIDEO, and VIDEO jacks, the priority order of the input signals is as follows:
  1. HDMI
  2. COMPONENT VIDEO
  3. S VIDEO
  4. VIDEO
- Digital video signals input at one of the HDMI IN jacks cannot be output from analog video output jacks.
- The analog component video signals with 480i (NTSC)/576i (PAL) of resolution are converted to the S-video or composite video signals and output at the S VIDEO MONITOR OUT and VIDEO MONITOR OUT jacks.
- The analog component video signals with 1080p of resolution are only output at the COMPONENT VIDEO MONITOR OUT jacks.

## Connecting a TV monitor or projector

Connect your TV (or projector) to the HDMI OUT jack, the COMPONENT VIDEO MONITOR OUT jacks, the S VIDEO MONITOR OUT jack or the VIDEO MONITOR OUT jack of this unit.



Make sure that this unit and other components are unplugged from the AC wall outlets.



- You can choose to play back HDMI audio signals on this unit or on another HDMI component connected to the HDMI OUT jack of this unit. Use the “S.AUDIO” parameter in “OPTION MENU” to select the component to play back HDMI audio signals (see page 81).

- When you use the internal tuner of the TV as the input source, connect the digital or analog audio output jacks of the TV and digital or analog audio input jacks of this unit. Refer to “Connecting a set-top box” on page 22 for connecting information.

### Notes

- If a video monitor is connected to this unit via a DVI connection, you may not take full advantage of the HDMI features.
- Some video monitors connected to this unit via a DVI connection fail to recognize the HDMI audio/video signals being input if they are in the standby mode. In this case, the HDMI indicator flashes irregularly.
- If the connected video monitor is compatible with the automatic audio and video synchronization feature (automatic lip sync feature), this unit adjusts the audio and video timing automatically (see page 75). Connect the video monitor to the HDMI OUT jack of this unit to use the feature.

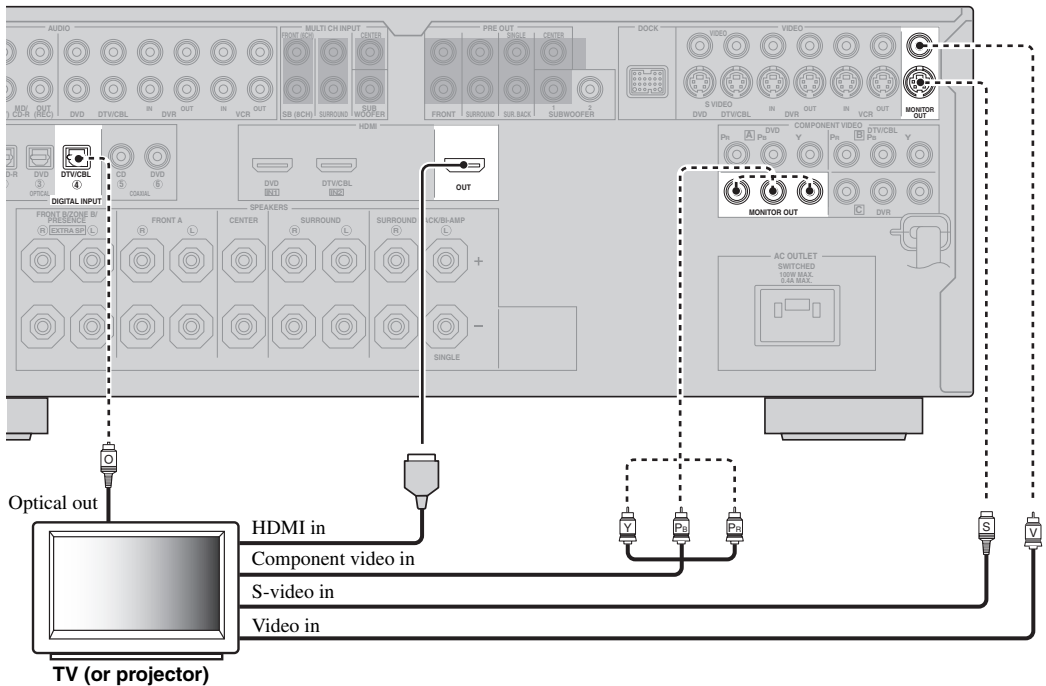

———— indicates recommended connections  
 - - - - - indicates alternative connections  
 (One for the video connection, and one for the audio connection)

## Connecting other components



Make sure that this unit and other components are unplugged from the AC wall outlets.

### Notes

- When “VIDEO CONV.” is set to “OFF” (see page 80), be sure to make the same type of video connections as those made for your TV (see page 20). For example, if you connected your TV to the VIDEO MONITOR OUT jack of this unit, connect your other components to the VIDEO jacks.

### ■ Connecting a DVD player

- When “VIDEO CONV.” is set to “ON” (see page 80), the converted video signals are output only at the MONITOR OUT jacks. To record a source, make the same type of video connections between each component.
- To make a digital connection to a component other than the default component assigned to each DIGITAL INPUT or DIGITAL OUTPUT jack, select the corresponding setting for “OPTICAL OUT”, “OPTICAL IN”, or “COAXIAL IN” in “I/O ASSIGNMENT” (see page 76).
- If you connect your DVD player to both the DIGITAL INPUT (OPTICAL) and the DIGITAL INPUT (COAXIAL) jacks, priority is given to the signals input at the DIGITAL INPUT (COAXIAL) jack.

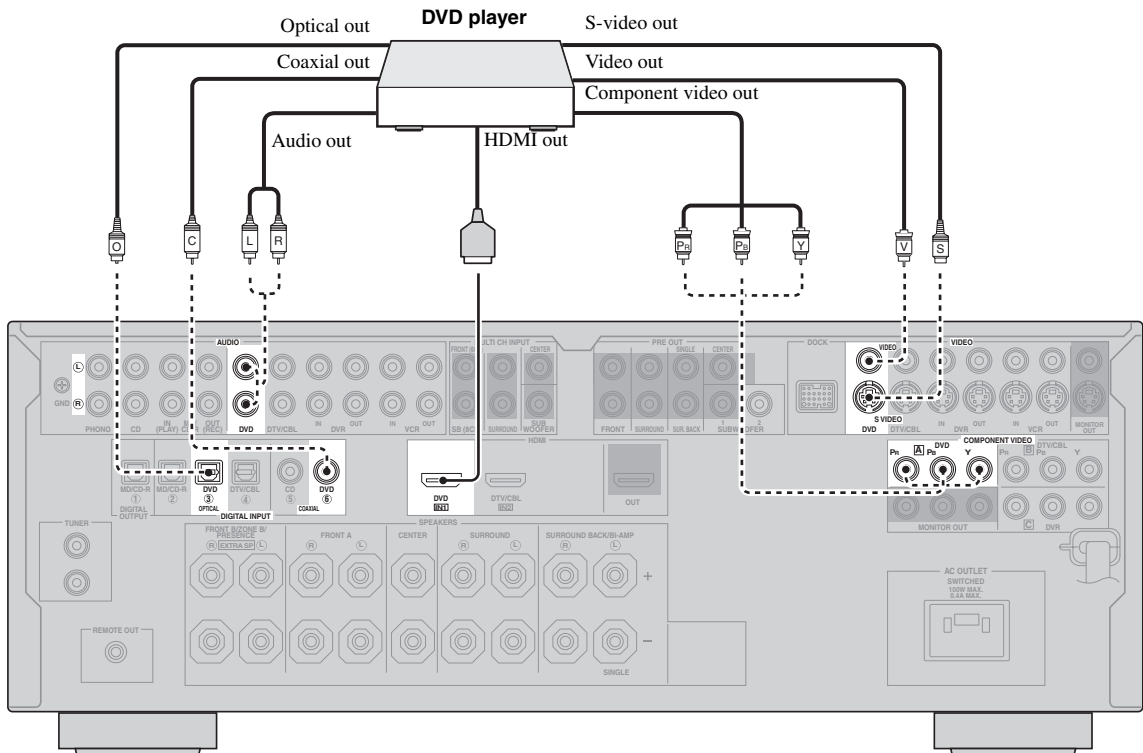

———— indicates recommended connections

- - - - - indicates alternative connections  
(One for the video connection, and one for the audio connection)

■ Connecting a DVD recorder, PVR or VCR

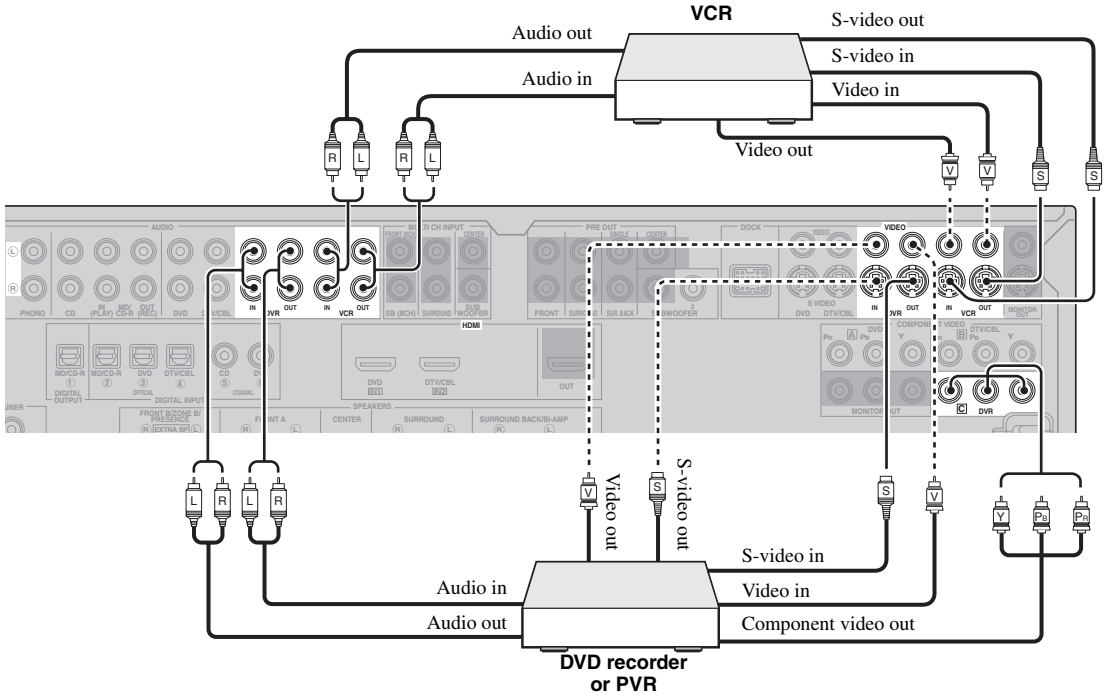

■ Connecting a set-top box

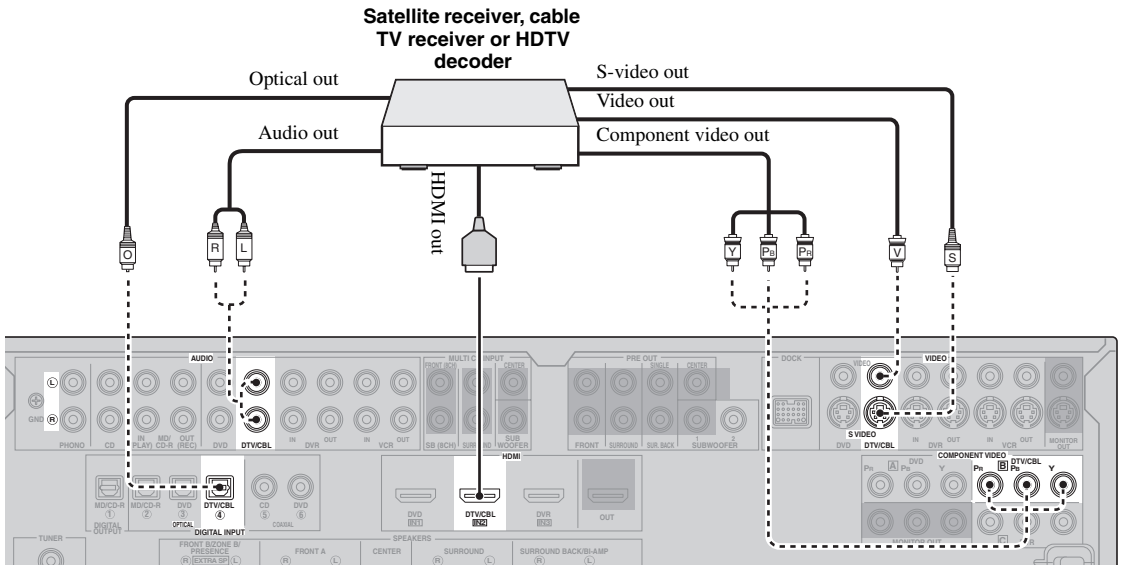

— indicates recommended connections  
 - - - indicates alternative connections  
 (One for the video connection, and one for the audio connection)



## ■ Connecting audio components

### Notes

- To make a digital connection to a component other than the default component assigned to each the DIGITAL INPUT jack or the DIGITAL OUTPUT jack, select the corresponding setting for “OPTICAL OUT”, “OPTICAL IN”, or “COAXIAL IN” in “I/O ASSIGNMENT” (see page 76).
- Connect your turntable to the GND terminal of this unit to reduce noise in the signal. However, you may hear less noise without the connection to the GND terminal for some turntables.
- The PHONO jacks are only compatible with a turntable with an MM or a high-output MC cartridge. To connect a turntable with a low-output MC cartridge to the PHONO jacks, use an in-line boosting transformer or an MC-head amplifier.
- When you connect both the DIGITAL INPUT (OPTICAL) jack and the DIGITAL INPUT (COAXIAL) jack to an audio component, the priority is given to the DIGITAL INPUT (COAXIAL) jack.

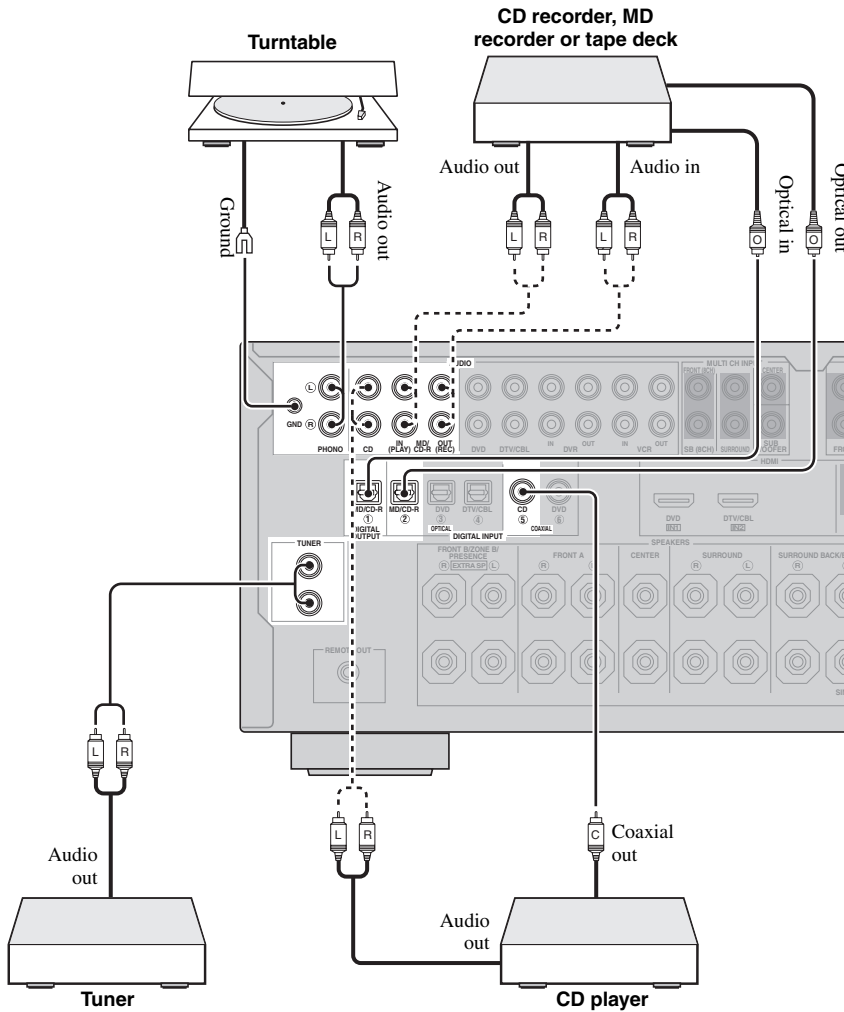

————— indicates recommended connections  
 - - - - - indicates alternative connections  
 (One for the audio connection)

## ■ Connecting an external amplifier

This unit has more than enough power for any home use. However, if you want to add more power to the speaker output or if you want to use another amplifier, connect an external amplifier to the PRE OUT jacks. Each PRE OUT jack outputs the same channel signals as the corresponding SPEAKERS terminals.

### Notes

- When you make connections to the PRE OUT jacks, do not make connections to the SPEAKERS terminals.
- The signals output at the FRONT PRE OUT jacks are affected by the TONE CONTROL settings (see page 51).
- Adjust the volume level of the subwoofer with the control on the subwoofer (see page 51).
- Some signals may not be output at the SUBWOOFER PRE OUT jacks depending on the settings for “SPEAKER SET” (see page 68).

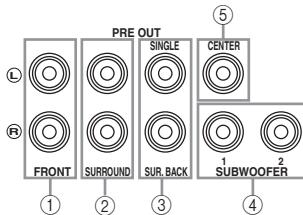

### ① FRONT PRE OUT jacks

Front channel output jacks.

### ② SURROUND PRE OUT jacks

Surround channel output jacks.

### ③ SUR.BACK PRE OUT jacks

Surround back channel output jacks. When you only connect one external amplifier for the surround back channel, connect it to the SINGLE jack.

### Notes

- When “BI-AMP” is set to “ON”, this unit outputs the front channel audio signals at the SUR.BACK PRE OUT jacks.
- The audio signals output at the SUR.BACK PRE OUT jacks differ depending on the “EXTRA SP ASSIGN” setting (see pages 32 and 68).

### ④ SUBWOOFER PRE OUT jacks

Connect one or two subwoofers with a built-in amplifier.

### Note

The signal output at the SUBWOOFER PRE OUT 2 jack is the same as the one output at the SUBWOOFER PRE OUT 1 jack.

### ⑤ CENTER PRE OUT jack

Center channel output jack.

## ■ Connecting a multi-format player or an external decoder

This unit is equipped with 6 additional input jacks (left and right FRONT, CENTER, left and right SURROUND and SUBWOOFER) for discrete multi-channel input from a multi-format player, external decoder, sound processor or pre-amplifier.

If you set "INPUT CH" to "8CH" in "MULTI CH" (see page 78), you can use the input jacks assigned as "FRONT" in "MULTI CH" (see page 78) together with the MULTI CH INPUT jacks to input 8-channel signals.

Connect the output jacks on your multi-format player or external decoder to the MULTI CH INPUT jacks. Be sure to match the left and right outputs to the left and right input jacks for the front and surround channels.

### Notes

- When you select the component connected to the MULTI CH INPUT jacks as the input source (see page 42), this unit automatically turns off the digital sound field processor, and you cannot select sound field programs.
- This unit does not redirect signals input at the MULTI CH INPUT jacks to accommodate for missing speakers. We recommend that you connect at least a 5.1-channel speaker system before using this feature.

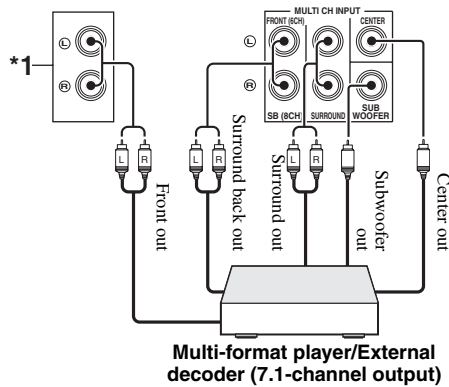
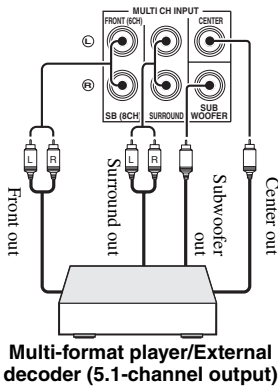

\*1 The analog audio input jacks assigned as "FRONT" in "MULTI CH" (see page 78).

## ■ Connecting a Yamaha iPod universal dock or Bluetooth adapter

This unit is equipped with the DOCK terminal on the rear panel that allows you to connect a Yamaha iPod universal dock (such as YDS-10, sold separately) or Bluetooth adapter (such as YBA-10, sold separately). Connect a Yamaha iPod universal dock or Bluetooth adapter to the DOCK terminal on the rear panel of this unit using its dedicated cable.



Refer to "Using iPod™" on page 52 for playback of your iPod and "Using Bluetooth™ components" on page 54 for playback of your Bluetooth components.

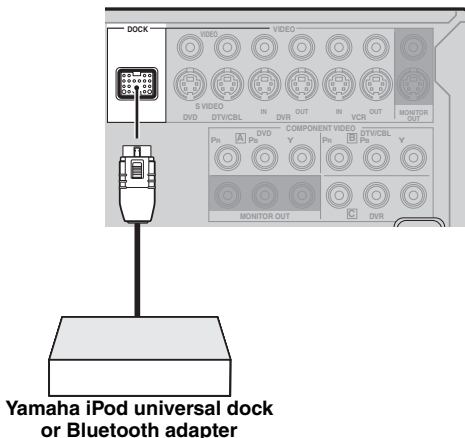

### ■ Using REMOTE OUT jack

Connect the component which is the Yamaha product and have the capability of the SCENE control signals to the REMOTE OUT jack as follows.

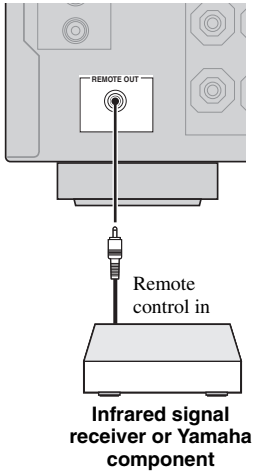

- If the components have the capability of the SCENE control signals, this unit can automatically activate the corresponding components and start the playback when you use one of the SCENE buttons. Refer to the owner's manuals for details about the capability of the SCENE control signals of the components.
- If the component connected to the REMOTE OUT jack is not the Yamaha product, set "SCENE IR" in the advanced setup menu to "OFF" (see page 96).

### Using the VIDEO AUX jacks on the front panel

Use the VIDEO AUX jacks on the front panel to connect a game console or a video camera to this unit.

#### Caution

Be sure to turn down the volume of this unit and other components before making connections.

#### Notes

- The audio signals input at the DOCK terminal on the rear panel take priority over the ones input at the VIDEO AUX jacks.
- To reproduce the source signals input at these jacks, select "V-AUX" as the input source.

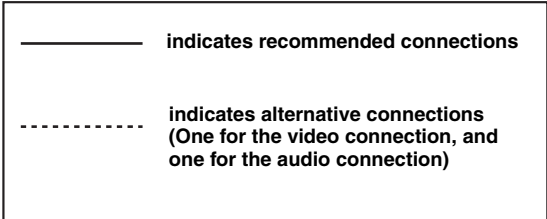
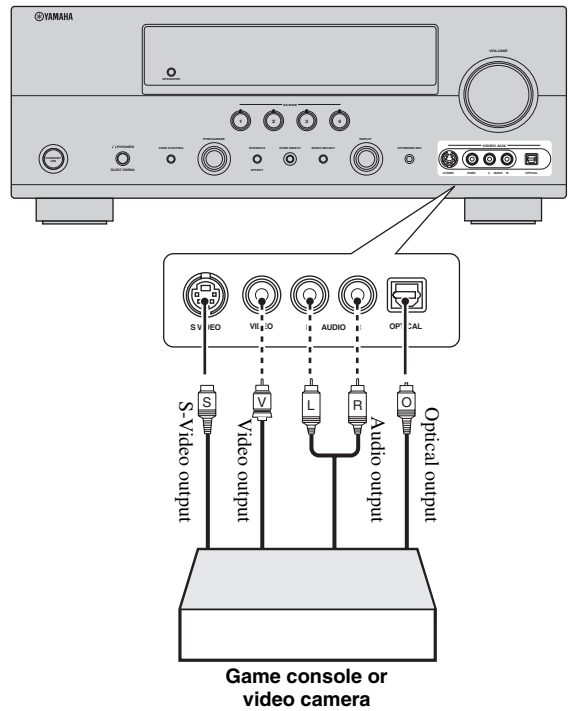

## Connecting the power cable

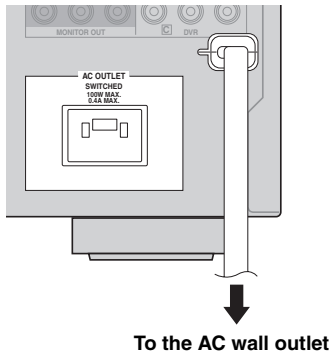

### ■ AC OUTLET (SWITCHED)

Use this outlet to supply power to any connected components. Connect the power cable of your other components to this outlet. Power to this outlet is supplied when this unit is turned on. However, power to this outlet is cut off when this unit is turned off or when **ⓄSTANDBY/ON** on the front panel is pressed. For information on the maximum power or the total power consumption of the components that can be connected to this outlet, see “Specifications” on page 109.

#### Note

The power to AC OUTLET of this unit is not cut off while this unit is charging connected iPod even when this unit is in the standby mode. When this unit completes charging or the iPod is disconnected, the power is cut off automatically when this unit is in the standby mode.

#### Memory back-up

The memory back-up circuit prevents the stored data from being lost even if this unit is in the standby mode. However, the stored data will be lost in case the power cable is disconnected from the AC wall outlet or if the power supply is cut off for more than one week.

## Setting the speaker impedance

### Caution

If you are to use 6 ohm speakers, set “SP IMP.” to “6ΩMIN” as follows BEFORE using this unit. 4 ohm speakers can be also used as the front speakers.

- 1 Make sure this unit turned off.**  
See page 28 for details.
- 2 Press and hold **ⓄTONE CONTROL** and then press **ⓄSTANDBY/ON** to turn on this unit.**  
This unit turns on, and the advanced setup menu appears in the front panel display.



- 3 Rotate the **ⓄPROGRAM** selector to select “SP IMP.”.**  
“SP IMP.” and the current speaker impedance setting (“8Ω MIN”) appear in the front panel display.
- 4 Press **ⓄTONE CONTROL** repeatedly to select “6ΩMIN”.**
- 5 Press **ⓄSTANDBY/ON** to save the new setting and turn off this unit.**

#### Note

The setting you made is reflected next time you turn on this unit.

## *Turning this unit on and off*

### ■ Turning on this unit

---

Press **Ⓢ STANDBY/ON** (or **Ⓟ POWER**) to turn on this unit.



- When you turn on this unit, there will be delay for a few seconds before this unit can reproduce sound.
- You can also turn on this unit by pressing **Ⓜ SCENE** (or **Ⓞ SCENE**) buttons.

### ■ Set this unit to the standby mode

---

Press **Ⓢ STANDBY/ON** (or **Ⓦ STANDBY**) to set this unit to the standby mode.

In the standby mode, this unit consumes a small amount of power in order to receive infrared signals from the remote control.

## Front panel display

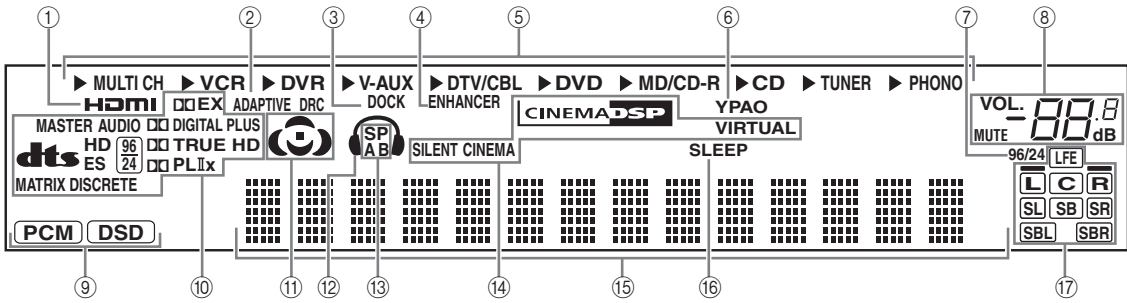

### ① HDMI indicator

Lights up when the signal of the selected input source is input at the HDMI IN jacks (see page 18).

### ② ADAPTIVE DRC indicator

Lights up when the adaptive dynamic range control feature is turned on (see page 72).

### ③ DOCK indicator

- Lights up when you station your iPod in a Yamaha iPod universal dock (such as YDS-10, sold separately) connected to the DOCK terminal of this unit (see page 25) and V-AUX is selected as the input source. The DOCK indicator also lights up when this unit is charging the battery of the stationed iPod in the standby mode.
- Flashes while the connected Yamaha Bluetooth adapter (such as YBA-10, sold separately) and the Bluetooth component is in the pairing or the Bluetooth adapter is searching the Bluetooth component (see page 54).
- Light up while the Yamaha Bluetooth adapter is connected to the Bluetooth component (see page 54).

### ④ ENHANCER indicator

Lights up when the Compressed Music Enhancer mode is selected (see page 49).

### ⑤ Input source indicators

The corresponding cursor lights up to show the currently selected input source.

### ⑥ YPAO indicator

Lights up when you run "AUTO SETUP" and when the speaker settings set in "AUTO SETUP" are used without any modifications (see page 31).

### ⑦ 96/24 indicator

Lights up when a DTS 96/24 signal is input to this unit.

### ⑧ MUTE indicator and VOLUME level indicator

- The MUTE indicator flashes while the MUTE function is on (see page 44).
- Indicates the current volume level.

### ⑨ Input signal indicators

Lights up when this unit is reproducing PCM (Pulse Code Modulation) or DSD (Direct Stream Digital) digital audio signals.

### ⑩ Decoder indicators

The respective indicator lights up when any of the decoders of this unit function.

### ⑪ Sound field indicators

Light up to indicate the active sound fields (see page 47).

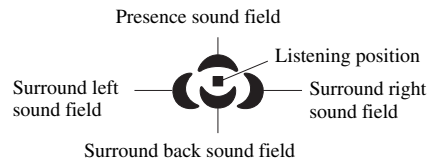

### ⑫ Headphone indicator

Lights up when headphones are connected (see page 44).

### ⑬ SP A B indicators

Light up according to the set of front speakers activated (see page 42).

SP A: The FRONT A speakers are activated.

SP B: The FRONT B speakers are activated.

SP A B: The FRONT A and FRONT B speakers are activated.

### ⑭ DSP indicators

The respective indicator lights up when any of the sound field programs are selected (see page 47).

#### CINEMA DSP indicator

Lights up when you select a CINEMA DSP sound field program (see page 47).

#### VIRTUAL indicator

Lights up when the Virtual CINEMA DSP mode is active (see page 50).

#### SILENT CINEMA indicator

Lights up when headphones are connected and a sound field program is selected (see page 50).

**15 Multi-information display**

Shows the name of the current sound field program and other information when adjusting or changing settings.

**16 SLEEP indicator**

Lights up while the sleep timer is on (see page 46).

**17 Input channel and speaker indicators**

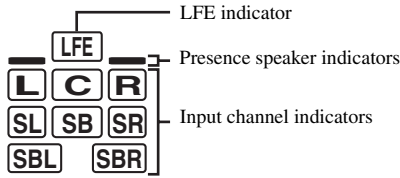

**Input channel indicators**

- Indicate the channel components of the current digital input signal.
- Light up or flash according to the settings of the speakers when this unit is in the automatic setup procedure (see page 31) or in the “BASIC MENU” in “MANUAL SETUP” (see page 70).

**Presence speaker indicators**

Light up or flash according to the setting of “EXTRA SP ASSIGN” when this unit is in the automatic setup procedure (see page 31) or in the “BASIC MENU” in “MANUAL SETUP” (see page 68).



You can make settings for the presence and surround back speakers automatically by running “AUTO SETUP” (see page 31) or manually by adjusting settings for “SUR.B L/R SP” (see page 69) in “SPEAKER SET”.

**Using the remote control**

The remote control transmits a directional infrared ray. Be sure to aim the remote control directly at the remote control sensor on this unit during operation.

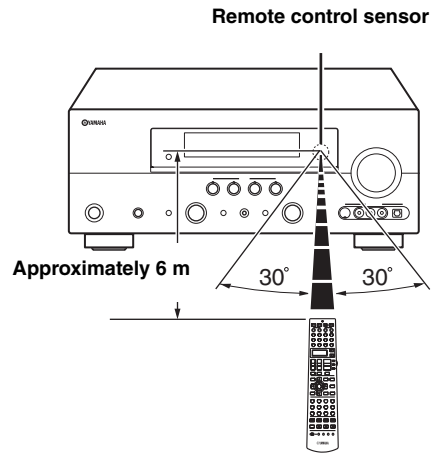

**Infrared window (①)**

Outputs infrared control signals. Aim this window at the component you want to operate.

**Transmit indicator (②)**

Flashes while the remote control is sending infrared signals.

**Display window (③)**

Shows the name of the selected input source that you can control.

**Operation mode selector (④)**

The function of some buttons depends on the operation mode selector position.

**AMP**

Operates the amplifier function of this unit.

**SOURCE**

Operates the component selected with an input selector button (see page 83).

**TV**

Operates the TV assigned to either DTV/CBL or PHONO (see page 82).

**Notes**

- Do not spill water or other liquids on the remote control.
- Do not drop the remote control.
- Do not leave or store the remote control in the following types of conditions:
  - places of high humidity, such as near a bath
  - places of high temperatures, such as near a heater or stove
  - places of extremely low temperatures
  - dusty places
- To set the remote control codes for other components, see page 84.



# Optimizing the speaker setting for your listening room (YPAO)

This unit employs the YPAO (Yamaha Parametric Room Acoustic Optimizer) technology which lets you avoid troublesome listening-based speaker setup and achieves highly accurate sound adjustments automatically. The supplied optimizer microphone collects and this unit analyzes the sound your speakers produce in your actual listening environment.

## Using AUTO SETUP

### Notes

- Be advised that it is normal for loud test tones to be output during the “AUTO SETUP” procedure.
- To achieve the best results, make sure the room is as quiet as possible while the “AUTO SETUP” procedure is in progress. If there is too much ambient noise, the results may not be satisfactory.



- Initial settings are indicated in bold.
- You can run “AUTO SETUP” using the system menu that appears in the OSD or in the front panel display. This manual uses the OSD illustrations to explain the “AUTO SETUP” procedure.
- Before performing operations, set the operation mode selector on the remote control to **AMP**.
- This unit uses the speakers connected to the FRONT A speaker terminals as the front speakers for the adjustment.

## 1 Make sure of the following check points.

### Note

Before starting the automatic setup, check the following check points.

- Speakers are connected appropriately.
- Headphones are disconnected from this unit.
- This unit and the video monitor are turned on.
- This unit is selected as the video input source of the video monitor.
- The connected subwoofer is turned on and the volume level is set to about half way (or slightly less).
- The crossover frequency controls of the connected subwoofer is set to the maximum.

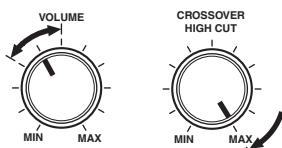

Controls of a subwoofer (example)

- The room is sufficiently quiet.



If you connect two subwoofers to this unit, the volume level of each subwoofer is set to slightly less.

## 2 Connect the supplied optimizer microphone to the OPTIMIZER MIC jack on the front panel.

“MIC ON View OSD menu” appears in the front panel display.

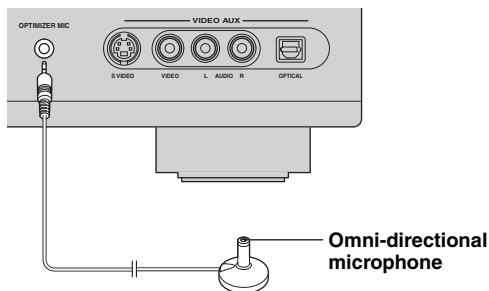

The following menu screen appears on the video monitor.

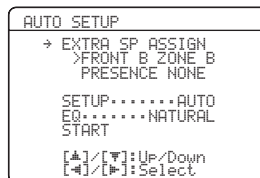

## 3 Place the optimizer microphone at your normal listening position on a flat level surface with the omni-directional microphone heading upward.

Optimizer microphone

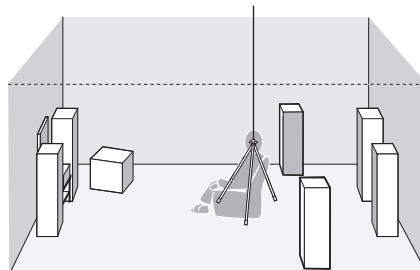

It is recommended that you use a tripod (etc.) to affix the optimizer microphone at the same height as your ears would be when you are seated in your listening position. You can use the attached screw of a tripod (etc.) to fix the optimizer microphone to the tripod (etc.).

**4 Press  $\text{Ⓢ}$  </> to select the desired setting for “EXTRA SP ASSIGN” and then press  $\text{Ⓢ}$  ▾.**

**Extra speaker assignment**

EXTRA SP ASSIGN

Selects the function of the speakers connected to the EXTRA SP terminals.

Choices: **FRONT B**, ZONE B, PRESENCE, NONE

- **When you use the alternative front speaker system (see page 42)**  
Select “FRONT B”.
- **When you want to use another front speaker system in Zone B**  
Select “ZONE B”.
- **When you use the presence speakers (see page 13)**  
Select “PRESENCE” to set the function of the speakers to the presence speakers.
- **When you do not use the EXTRA SP terminals**  
Select “NONE” to deactivate the EXTRA SP terminals.

**Note**

If you select “ON” in “BI-AMP” (see page 96), you cannot select “PRESENCE” in “EXTRA SP ASSIGN”.

**5 Press  $\text{Ⓢ}$  </> to select “SETUP” and then press  $\text{Ⓢ}$  ▾.**

Choices: **AUTO**, RELOAD, UNDO, DEFAULT

- Select “AUTO” to automatically run the entire “AUTO SETUP” procedure.
- Select “RELOAD” to reload the last “AUTO SETUP” settings and override the previous settings.
- Select “UNDO” to undo the last “AUTO SETUP” settings and restore the previous settings.
- Select “DEFAULT” to reset the “AUTO SETUP” parameters to the initial factory settings.

**Notes**

- “RELOAD” or “UNDO” is available only when you have previously run “AUTO SETUP” and confirmed the results.
- “RELOAD” or “UNDO” is not available when you change the setting of “BI-AMP” in the advanced setup (see page 96) or “EXTRA SP ASSIGN” in “BASIC MENU” (see page 68).

**6 Press  $\text{Ⓢ}$  </> to select the desired setting of “EQ”.**

**Parametric equalizer type  $\text{EQ}$**

Parametric equalizer adjusts the level of the specified frequency bands. This unit automatically selects the crucial frequency bands for the listening room and adjusts the level of the selected frequency bands to create a cohesive sound field in the room. You can select the type of the parametric equalizer adjustment from the following choices.

Choices: **NATURAL**, FLAT, FRONT

- Select “NATURAL” to average out the frequency response of all speakers with higher frequencies being all speakers to achieve more natural sound. Recommended if the FLAT setting sounds a little harsh.
- Select “FLAT” to average the frequency response of all speakers. Recommended if all of your speakers are of similar quality.
- Select “FRONT” to adjust the frequency response of each speaker in accordance with the sound of your front speakers. Recommended if your front speakers are of much higher quality than your other speakers.

**7 Press  $\text{\textcircled{9}}$   $\nabla$  to select “START” and then press  $\text{\textcircled{9}}$  **ENTER** to start the setup procedure.**

The following message appears in the OSD.  
When this unit starts the automatic setup procedure, loud test tones are output at the speakers.  
For more accurate measurements, keep quiet and move to the wall where speakers are not around. We recommend that you leave the listening room during the automatic setup procedure.

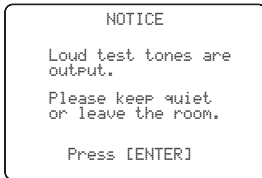

Once you perform the next operation, this unit starts the automatic setup procedure.

**8 Press  $\text{\textcircled{9}}$  **ENTER** to start the automatic setup procedure.**

The following screen appears in the OSD and setup procedure starts in 10 seconds.

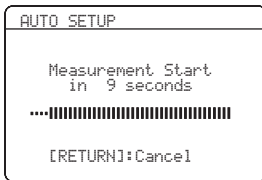

Loud test tones are output from each speaker during the auto setup procedure. Once all items are set, the “RESULT” display appears in the OSD.

**Notes**

- During the automatic setup procedure, do not perform any operation on this unit.
- We recommend that you get out of the room while this unit is in the auto setup procedure. It takes approximately 3 minutes for this unit to complete the auto setup procedure.



Press  $\text{\textcircled{9}}$   $\triangle$  to cancel the automatic setup procedure.

**9 Make sure that the following screen appears and then press  $\text{\textcircled{9}}$  **ENTER** to display the result screen.**

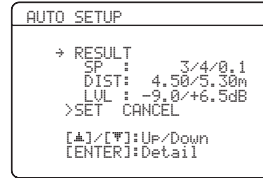

The results displayed under “RESULT” are as follows:

**Number of speakers SP**

Displays the number of speakers connected to this unit in the following order:  
Front/Back/Subwoofer

**Speaker distance DIST**

Displays the speaker distance from the listening position in the following order:  
Closest speaker distance/Farthest speaker distance

**Speaker level LVL**

Displays the speaker output level in the following order:  
Lowest speaker output level/Highest speaker output level

**Notes**

- The signal output at the SUBWOOFER PRE OUT 2 jack is the same as the one output at the SUBWOOFER PRE OUT 1 jack. Therefore, even if you connect two subwoofers, the number of the connected subwoofer is indicated as “0.1”.
- If “E-10:INTERNAL ERROR” appears during the testing procedure, restart from step 4.
- If you selected other than “AUTO” in step 5, no test tones are output.
- If an error occurs during the “AUTO SETUP” procedure, the setup procedure is canceled and an error screen appears. For details, see “If an error screen appears” on page 35.
- When this unit detects potential problems during the “AUTO SETUP” procedure, “WARNING” and the number of warning messages appears in the above of “RESULT” (see page 35).
- Depending on the listening environment, “SWFR PHASE:REV” appears during the automatic procedure and “SUBWOOFER PHASE” in “SOUND MENU” (see page 70) is automatically set to “REVERSE”.

**10** Press **Ⓢ** **ENTER** to display the setup results in detail.

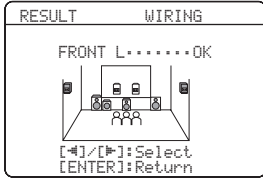
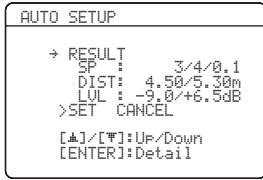

**11** Press **Ⓢ** **</>** repeatedly to toggle between the setup result displays.

Press **Ⓢ** **▲** / **▼** to toggle between the parameters in a results.

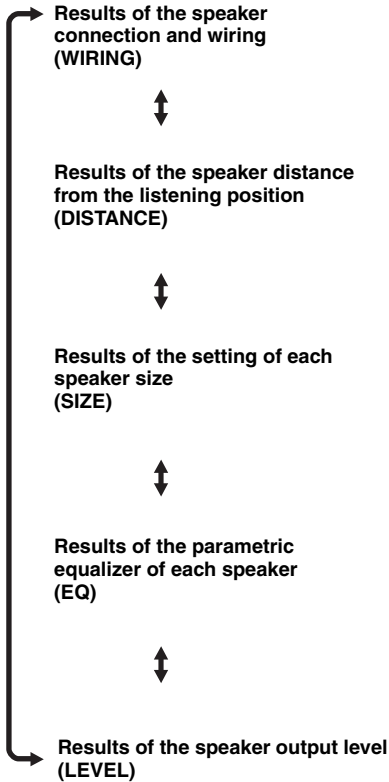

If you are not satisfied with the results or want to manually adjust each parameter, use “MANUAL SETUP” (see page 63).

**Notes**

- The distances displayed in the “DISTANCE” results may be longer than the actual distance depending on the characteristics of your subwoofer.
- In the “EQ” results, different values may be set for the same frequency to provide finer adjustments.

**12** Press **Ⓢ** **ENTER** to return to the top result display.

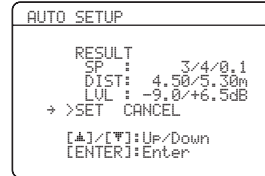

**13** Make sure the pointer is pointing at “SET” and “CANCEL” and then press **Ⓢ** **</>** to select “SET” or “CANCEL”.

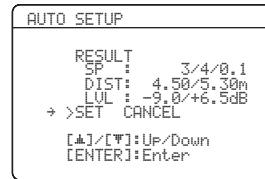

Choices: **SET**, **CANCEL**

- Select “SET” to confirm the “AUTO SETUP” results.
- Select “CANCEL” to cancel the “AUTO SETUP” results.

**14** Press **Ⓢ** **ENTER** to confirm your selection.

The following screen appears. Disconnect the optimizer microphone from this unit to exit from “SET MENU”. The optimizer microphone is sensitive to heat. Keep it away from direct sunlight and do not place it on top of this unit.



If you change speakers, speaker positions, or the layout of your listening environment, run “AUTO SETUP” again to recalibrate your system.

## ■ If an error screen appears

Press **⊙**/**△**/**▽**/**◀**/**▶** to select **“RETRY”** or **“EXIT”** and then press **⊙****ENTER**.

The following display is an example when “E-9:USER CANCEL” appears in the OSD.

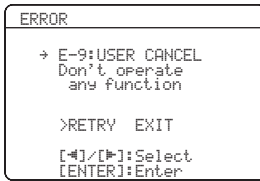

Choices: **RETRY**, **EXIT**

- Select **“RETRY”** to retry the **“AUTO SETUP”** procedure.
- Select **“EXIT”** to exit from the **“AUTO SETUP”** procedure.



If “E-5:NOISY” appears, **“PROCEED”** also appears in the choices. When you select **“PROCEED”**, this unit continues the measurements and settings, but the settings may not be optimal.

## ■ If “WARNING” appears

When this unit detects potential problems during the **“AUTO SETUP”** procedure, **“WARNING”** appears in the top result display. Check the warning messages to correct your speaker settings.

### Note

Warnings differ from errors in that warnings do not cancel the **“AUTO SETUP”** procedure.

## 1 Make sure the pointer is pointing at **“WARNING”** and then press **⊙****ENTER** to display the detailed information about the warning.

The number on the right of **“WARNING”** indicates the number of warning messages.

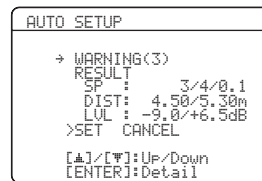

## 2 Press **⊙**/**◀**/**▶** repeatedly to toggle between the warning displays.

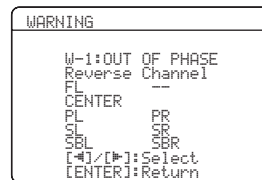

- For details about each warning message, see the **“AUTO SETUP”** section in **“Troubleshooting”** on page 102.
- When the corresponding warning message is not applicable to a speaker, **“—”** is displayed instead.
- If **“SWFR: TOO LOUD”** or **“SWFR: TOO LOW”** appears in the **“W-3: LEVEL ERROR”** display, adjust the volume level of the subwoofer(s).

## 3 Press **⊙****ENTER** to return to the top result display.

# Selecting the SCENE templates

This unit is equipped with 17 preset SCENE templates for various situations of using this unit. As the initial factory setting, the following SCENE templates are assigned to each SCENE button (see page 8):

**SCENE 1:** DVD Movie Viewing

**SCENE 2:** Music Disc Listening

**SCENE 3:** TV Viewing

**SCENE 4:** Radio Listening

If you want to use other SCENE templates, you can select the desired SCENE templates from the SCENE template library and assign the templates to the selected SCENE buttons on the front panel and the remote control.

Select the desired SCENE template

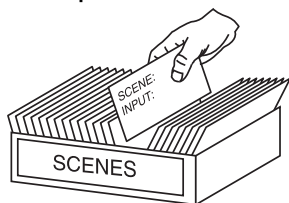

SCENE template library (Image)



Assign the SCENE template to the SCENE button

## Selecting the desired SCENE template to the SCENE buttons

- 1 Press and hold the **⓵SCENE** (or **④SCENE**) button for 3 seconds.

The indicator on the selected SCENE button on the front panel starts to flash, and the name of the currently assigned SCENE template appears in the front panel display.

3 seconds



Front panel

or

3 seconds



Remote control



Flashes

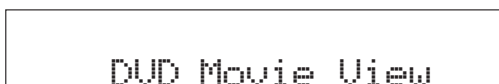

- 2 Rotate the **⓵INPUT** selector (or set the operation mode selector to **⓶AMP** and then press **⓸◀/▶**) to select the desired template.

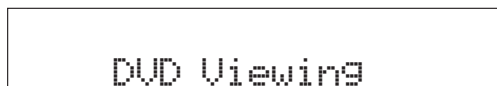

- 3 Press the **⓵SCENE** (or **④SCENE**) button again to confirm the selection.

The selected SCENE template is assigned to the SCENE button.

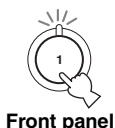

Front panel

or



Remote control

### Note

Once the desired SCENE templates are assigned to the corresponding SCENE buttons, you need to set the input source of the SCENE template on the remote control. See page 40 for details.

■ Which SCENE template would you like to select?

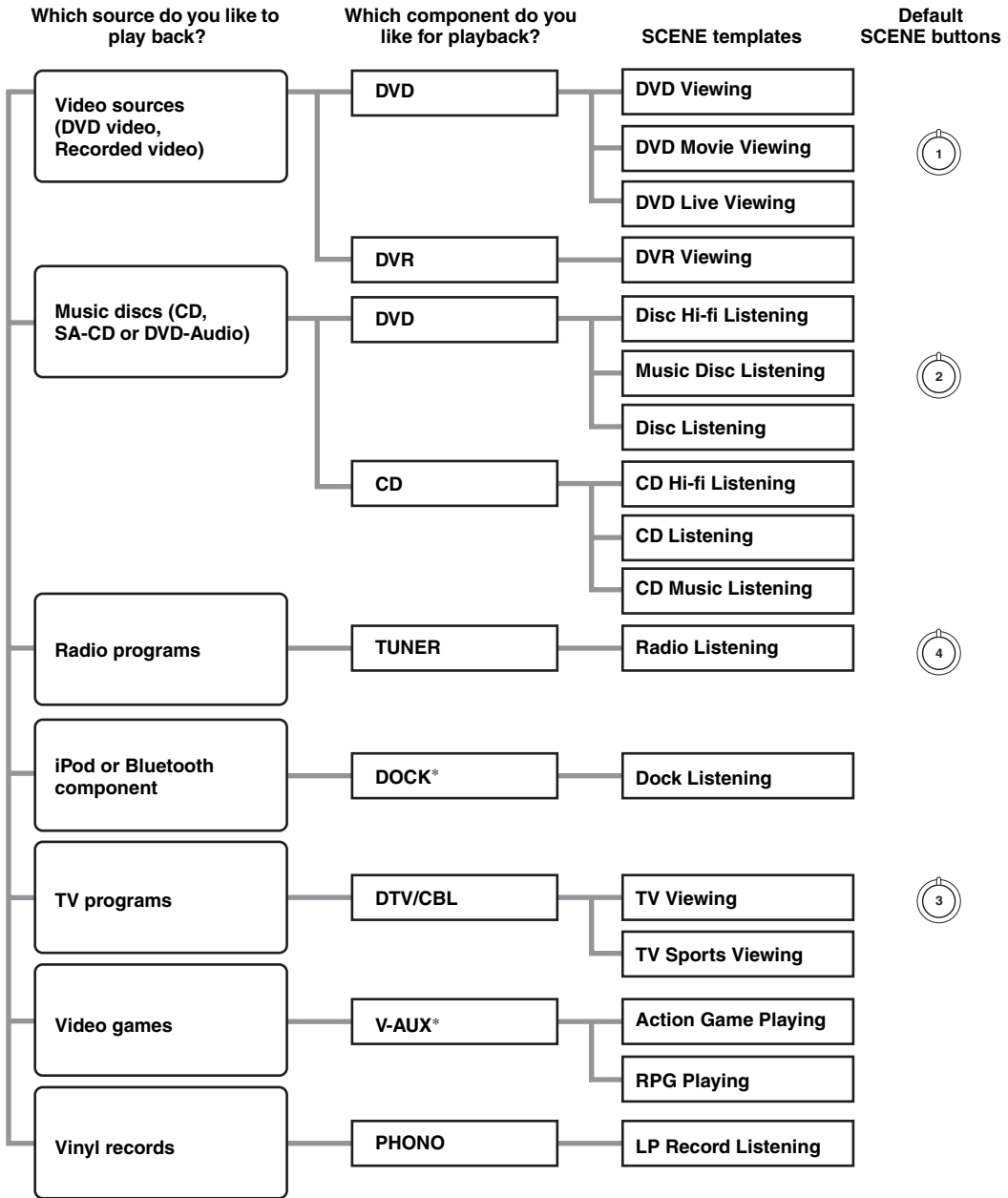

**Note**





\* When iPod is connected to the Yamaha iPod universal dock or a Bluetooth component is connected to the Bluetooth adapter, this unit plays back the audio sources input at the DOCK terminal.



You can create your original SCENE templates by editing the preset SCENE templates. See page 39 for details.

## ■ Preset SCENE templates descriptions

The illustrations of the SCENE button in the following table indicate the assigned SCENE buttons in the default setting.

SCENE template	Input source	Playback mode	Features
DVD Viewing	DVD*	Straight	Select this SCENE template when you play back general contents on the DVD player.
DVD Movie Viewing 	DVD*	MOVIE Sci-Fi	Select this SCENE template when you play back movies on your DVD player.
DVD Live Viewing	DVD*	ENTERTAINMENT Music Video	Select this SCENE template when you enjoy the music live video on your DVD player.
DVR Viewing	DVR	MOVIE Drama	Select this SCENE template when you play back movies on your digital video recorder.
Disc Hi-fi Listening	DVD*	Pure Direct	Select this SCENE template when you enjoy the high fidelity sound of the music discs on your DVD player.
Music Disc Listening 	DVD*	STEREO 2ch Stereo	Select this SCENE template when you play back music discs on your DVD player.
Disc Listening	DVD*	STEREO 7ch Stereo	Select this SCENE template when you play back music sources on your DVD player as the background music.
CD Hi-fi Listening	CD*	Pure Direct	Select this SCENE template when you enjoy the high fidelity sound of the music discs on your CD player.
CD Listening	CD*	STEREO 7ch Stereo	Select this SCENE template when you play back music discs on your CD player.
CD Music Listening	CD*	STEREO 2ch Stereo	Select this SCENE template when you play back music source on your CD player as the background music.
Radio Listening 	TUNER	MUSIC ENHANCER 7ch Enhancer	Select this SCENE template when you enjoy radio programs.
Dock Listening	V-AUX	MUSIC ENHANCER 7ch Enhancer	Select this SCENE template when you play back music on your iPod stationed in a Yamaha iPod universal dock or Bluetooth component that is connected to the Bluetooth adapter.
TV Viewing 	DTV/CBL	Straight	Select this SCENE template when you enjoy general programs on your TV.
TV Sports Viewing	DTV/CBL	ENTERTAINMENT Sports	Select this SCENE template when you enjoy sports programs on your TV.
Action Game Playing	V-AUX	ENTERTAINMENT Action Game	Select this SCENE template when you play action games such as car racing and FPS games.
RPG Playing	V-AUX	ENTERTAINMENT Roleplaying Game	Select this SCENE template when you play role-playing games.
LP Record Listening	PHONO	Pure Direct	Select this SCENE template when you play back vinyl records on your turntable.

\* When the connected DVD player or CD player has the capability of the SCENE control signals and is connected to the REMOTE OUT jack of this unit, this unit operates the DVD player or CD player worked with the SCENE features.



## Creating your original SCENE templates

You can create your original SCENE templates for each SCENE button. You can refer to the preset 17 SCENE templates to create the original SCENE templates.

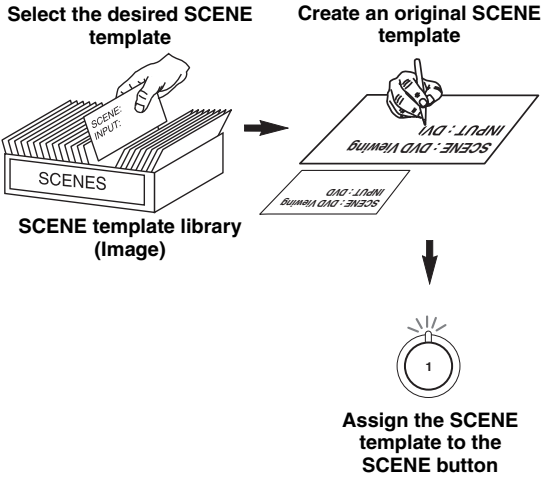

**1 Turn on the video monitor connected to this unit.**

**2 Press and hold the desired ④SCENE button for 3 seconds.**

The SCENE template customizing screen appears on the video monitor.

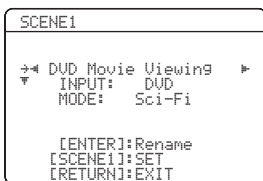

**Note**

When the SCENE template you want to customize is not assigned to any of the ④SCENE buttons, press ⑨◀/▶ repeatedly to recall the desired SCENE template on the menu screen.

**3 Press ⑨△/▽ to select the desired parameter of the SCENE template and then ⑨◀/▶ to select the desired value of the selected parameter.**

You can adjust the following parameters for a SCENE template:

- **INPUT:** The input source component.
- **MODE:** The active sound field programs, “Straight” or “Pure Direct” mode.

**4 Press the ④SCENE button again to confirm the edit.**



An asterisk mark (\*) appears by the name of the original SCENE template.

**Notes**

- Once the desired SCENE templates are assigned to the corresponding ④SCENE buttons, you need to set the input source of the SCENE template on the remote control. See page 40 for details.
- You can create a customized SCENE template for each SCENE button, and if you create another customized SCENE template, this unit overwrites the old customized SCENE template with the new one.
- The newly created template is only available for the assigned SCENE button.

**■ Rename the SCENE templates**

Select the name of the SCENE template at step 3 of “Creating your original SCENE templates” and then press ⑨ENTER.

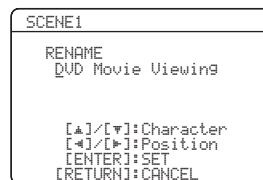

- Press ⑨△/▽ to select the desired character.
- Press ⑨◀/▶ to place an “\_” (underscore) under the space or the desired character.
- Press ⑩RETURN to cancel the new name.
- Press ⑨ENTER to confirm the new name.

## Using the remote control for the SCENE feature

### ■ Controlling the input source components in the SCENE mode

You can operate both this unit and the input source component by using the remote control. You must set the appropriate remote control code for each input source in advance (see page 84).

Before performing the following operations, set the operation mode selector on the remote control to **⑩SOURCE**.

- 1** Press the desired **④SCENE** button on the remote control.
- 2** Press the desired buttons in the \* area below to control the input source component of the selected SCENE template.

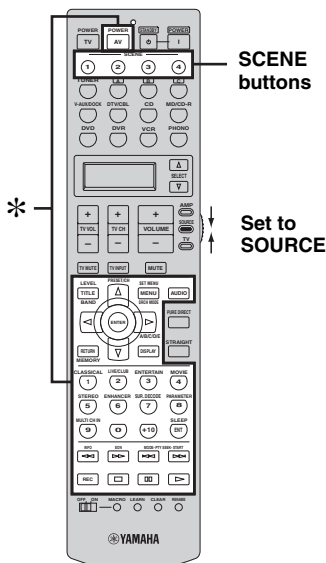

### ■ Setting the input source of the customized SCENE template on the remote control

If you customize the input source of the selected SCENE template, you must set the input source of the SCENE template on the remote control to operate the input source component correctly.

- 1** Press and hold the **④SCENE** button and the desired input selector button (**⑤**).  
The transmit indicator (**②**) flashes twice.
- 2** Keep holding down the buttons pressed in step 2 until “OK” appears in the display window (**⑥**) on the remote control.

**Note**

If the setting of the input source is not successful, “NG” appears in the display window (**⑥**). In this case, repeat the setting procedure.

**Note**

\* These buttons control the input source component. See page 83 for details of the function of each button.

# Playback

## Caution

Extreme caution should be exercised when you play back CDs encoded in DTS. If you play back a CD encoded in DTS on a DTS-incompatible CD player, you will only hear some unwanted noise that may damage your speakers. Check whether your CD player supports CDs encoded in DTS. Also, check the sound output level of your CD player before you play back a CD encoded in DTS.



To play DTS-encoded CDs when using a digital audio connection, set "DECODER MODE" in "INPUT MENU" to "DTS" before the playback (see page 77).

Before performing the following operations, set the operation mode selector on the remote control to **AMP**.

## Basic procedure

### 1 Turn on the video monitor connected to this unit.



See page 45 to display the input source information on the video monitor.

### 2 Rotate the **INPUT** selector (or press one of the input selector buttons) to select the desired input source.

The name of the currently selected input source appears in the front panel display for a few seconds.

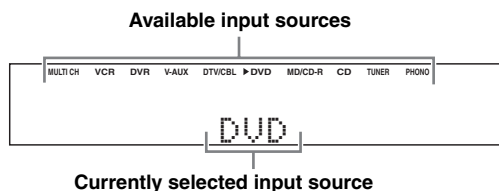

The corresponding input selector button on the remote control for the currently selected input source lights up for approximately 5 seconds after you press any buttons on the remote control, showing which source component is currently being operated.

### 3 Start playback on the selected source component or select a broadcast station.

- Refer to the operating instructions for the source component.
- See page 52 for details about iPod operations.
- See page 54 for details about Bluetooth operations.

### 4 Rotate **VOLUME** (or press **VOLUME +/-**) to adjust the volume to the desired output level.



- See page 51 to adjust the level of each speaker.
- This does not affect the AUDIO OUT (REC) level.
- You can set the initial volume level and maximum volume level (see page 72).

### 5 Rotate the **PROGRAM** selector (or press one of the sound field program selector buttons) repeatedly to select the desired sound field program.

The name of the selected sound field program appears in the front panel display. See page 47 for details about sound field programs.



## Note

Sound field programs cannot be selected when the component connected to the MULTI CH INPUT jacks is selected as the input source (see page 42).



- Choose a sound field program based on your listening preference, not merely on the name of the program.
- When you select an input source, this unit automatically selects the last sound field program used with the corresponding input source.
- To display information about the currently selected sound field program in the OSD, see page 56 for details.

Before performing the following operations, set the operation mode selector on the remote control to **AMP**.

## Selecting the MULTI CH INPUT component

Use this feature to select the component connected to the MULTI CH INPUT jacks (see page 25) as the input source.

Rotate the **INPUT** selector to select **"MULTI CH"** (or press **MULTI CH IN**).

"MULTI CH" appears in the front panel display.



Use "MULTI CH" menu in "INPUT MENU" to set the parameters for MULTI CH INPUT (see page 78).

### Note

Sound field programs cannot be selected when the component connected to the MULTI CH INPUT jacks is selected as the input source.

## Selecting the front speaker set

Use this feature to turn the front speaker system (FRONT A and/or FRONT B) on or off.

Press **SPEAKERS** on the front panel repeatedly to turn on or off the set of front speakers connected to the **FRONT A** and/or **EXTRA SP** speaker terminals.

The active front speaker set changes as follows.

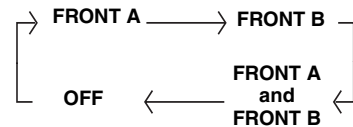

### Notes

- FRONT A and B or FRONT B setting is not available when "EXTRA SP ASSIGN" is set to "PRESENCE" or "NONE" (see page 68).
- Turn off the volume level of this unit when you switch the front speaker setting.

### Using the Zone B feature

When you set "EXTRA SP ASSIGN" to "ZONE B" (see page 68), you can use the speakers connected to the EXTRA SP speaker terminals in another room (Zone B).

Press **SPEAKERS** on the front panel repeatedly to turn on or off the Zone B speakers.

When you activate the Zone B speakers, all the speakers in the main room are muted.

### Note

If you select the sound field program and activate the Zone B speakers, Virtual CINEMA DSP activates automatically (see page 50).

Before performing the following operations, set the operation mode selector on the remote control to **AMP**.

## Selecting audio input jacks (AUDIO SELECT)

This unit comes with a variety of input jacks. Use this feature (audio input jack select) to switch between input jacks when more than one input jack is assigned to the same input source.



- We recommend that you set the audio input jack select to "AUTO" in most cases.
- You can adjust the default audio input jack select of this unit by using "AUDIO SELECT" in "OPTION MENU" (see page 81).

Press **AUDIO SELECT** (or **AUDIO**) repeatedly to select the desired audio input jack select setting.

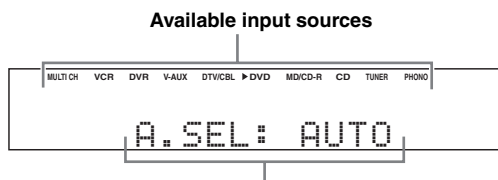

AUDIO SELECT	Function
AUTO	Automatically selects input signals in the following order: (1) HDMI (2) Digital signals (3) Analog signals
HDMI	Selects only HDMI signals. When HDMI signals are not input, no sound is output.
COAX/OPT	Automatically selects input signals in the following order: (1) Digital signals input at the COAXIAL jack (2) Digital signals input at the OPTICAL jack When no signals are input, no sound is output.
ANALOG	Selects only analog signals. If no analog signals are input, no sound is output.

### Note

This feature is not available when no digital input jacks (OPTICAL, COAXIAL and HDMI) are assigned. In addition, HDMI is not available as an audio input jack select setting when the HDMI IN jacks are not used. Use "I/O ASSIGNMENT" in "INPUT MENU" to reassign the respective input jack (see page 76).

## Displaying the current status of this unit on a video monitor

You can display the operating information of this unit on a video monitor.

- 1 Turn on the video monitor connected to this unit.
- 2 Press **DISPLAY** on the remote control.  
The current status screen appears in the OSD.

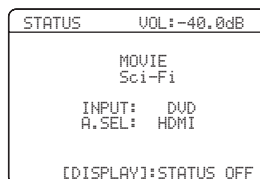

- You can select the amount of time that the current status is displayed in the OSD by using the "OSD-AMP" parameter in "OPTION MENU" (see page 79).
- To turn off the status screen, press **DISPLAY** again.

### Note

The OSD signal is not output at the DVR and VCR VIDEO OUT jacks and will not be recorded.

## Using your headphones

Connect a pair of headphones with a stereo analog audio cable plug to the PHONES jack on the front panel.

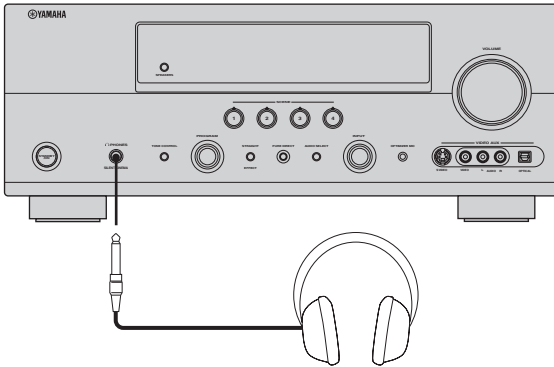

When you select a sound field program, SILENT CINEMA mode activates automatically (see page 50).

### Notes

- When you connect headphones, no signals are output at the speaker terminals.
- All Dolby Digital and DTS audio signals are mixed down to the left and right headphone channels.

## Muting the audio output

Press **MUTE** on the remote control to mute the audio output.

Press **MUTE** again to resume the audio output.



- You can also rotate **VOLUME** (or press **VOLUME +/-**) to resume the audio output.
- You can adjust the muting level by using the “MUTE TYPE” parameter in “VOLUME MENU” (see page 72).
- The MUTE indicator flashes in the front panel display when the audio output is muted and disappears from the front panel display when the audio output is resumed.

Before performing the following operations, set the operation mode selector on the remote control to **AMP**.

## Playing video sources in the background of an audio source

You can combine a video image from a video source with sound from an audio source. For example, you can enjoy listening to classical music while viewing beautiful scenery from the video source on the video monitor.

Press the input selector buttons (5) on the remote control to select a video source and then an audio source.

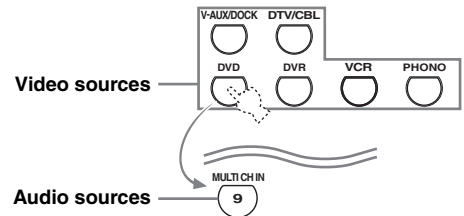
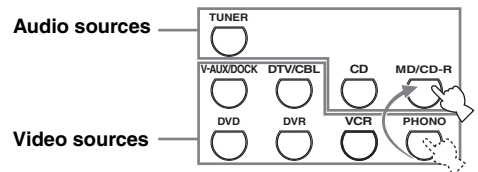

- You can also select “MULTI CH” as the audio source (see page 42). Set the operation mode selector to **AMP** and then press **MULTI CH IN**.
- Set the “BGV” parameter in the “MULTI CH” menu to the desired setting to select the default background video input source of the MULTI CH INPUT sources (see page 78).

## Displaying the input source information

You can display the audio and video information of the current input signal.

- 1 Set the operation mode selector to **AMP** and then press **SET MENU** on the remote control.

The top “SET MENU” display appears in the OSD.



- 2 Press **▽** repeatedly to select “SIGNAL INFO” and then press **ENTER**.

The audio information about the input source appears in the OSD.

- 3 Press **◀/▶** to toggle between the audio and video information displays.

- 4 Press **SET MENU** on the remote control again to exit from “SET MENU”.

## Audio information

Information	Descriptions
FORMAT	Signal format. When this unit cannot detect a digital signal, it automatically switches to analog input.
SAMPLING	The number of samples per second taken from a continuous signal to make a discrete signal.
CHANNEL	The number of source channels in the input signal (front/surround/LFE). For example, a multi-channel soundtrack with 3 front channels, 2 surround channels and LFE, is displayed as “3/2/0.1”.
BITRATE	The number of bits passing a given point per second.
FLAG	Flag data encoded in DTS, Dolby Digital, or PCM signals that cue this unit to automatically switch decoders (“Surround EX”, etc.).

### Note

“—” appears when this unit cannot display the corresponding information.

## Video information

Information	Descriptions
HDMI SIGNAL	Type of the source video signals and the video signals output at the HDMI OUT jack of this unit.
HDMI RES.	Resolution of the input signal (analog or HDMI) and the output signal (HDMI). When input video signals are composite video or S-video signals, the input video signals are indicated as “Composite” or “S-Video”.
ANALOG RES.	Resolution of the analog video signals output at the COMPONENT VIDEO MONITOR OUT jacks of this unit.
HDMI ERROR (HDMI MESSAGE)	Error message for HDMI sources or connected HDMI devices.

### Note

“—” appears when this unit cannot display the corresponding information.

## HDMI error and message

Message	Cause
DEVICE OVER	The number of the connected HDMI components is over the limit.
HDCP ERROR	HDCP authentication failed.
Out of Res.	Out of resolution. The connected monitor is not compatible with the resolution of the input video signal.

## Using the sleep timer

Use this feature to automatically set this unit to the standby mode after a certain amount of time. The sleep timer is useful when you are going to sleep while this unit is playing or recording a source. The sleep timer also automatically turns off any external components connected to the AC OUTLET (see page 27).

### Note

Even if this unit is in the standby mode, this unit does not cut off the power to AC OUTLET while charging connected iPod (see page 27).

**Set the operation mode selector to **AMP** and then press **SLEEP** repeatedly to set the amount of time.**

Each time you press **SLEEP**, the front panel display changes as shown below.

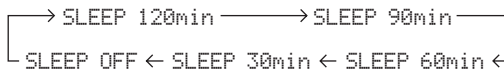

The SLEEP indicator flashes while you are switching the amount of time for the sleep timer. Once the sleep timer is set, the SLEEP indicator lights up in the front panel display, and the display returns to the selected sound field program.

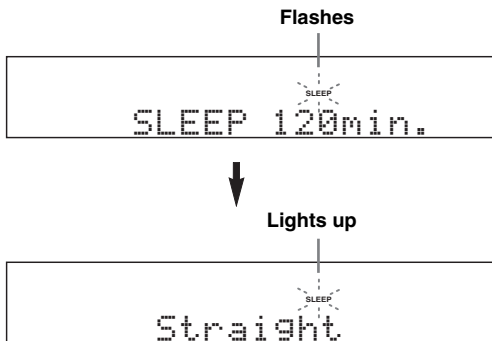

## Canceling the sleep timer

Press **SLEEP** on the remote control repeatedly until “SLEEP OFF” appears in the front panel display.

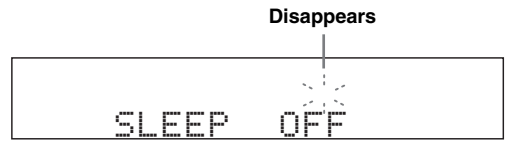

The SLEEP indicator turns off, and “SLEEP OFF” disappears from the front panel display after a few seconds.



The sleep timer setting can also be canceled by pressing **STANDBY** (or **STANDBY/ON**) to set this unit to the standby mode.



# Sound field programs

This unit is equipped with a variety of precise digital decoders that allow you to enjoy multi-channel playback from almost any stereo or multi-channel sound source. This unit is also equipped with a Yamaha digital sound field processing (DSP) chip containing several sound field programs which you can use to enhance your playback experience.

## Selecting sound field programs

Rotate the **PROGRAM** selector (or set the operation mode selector to **AMP** and then press one of the sound field program selector buttons (⊗) repeatedly).

The name of the selected sound field program appears in the front panel display and in the OSD.

### Notes

- When you select an input source, this unit automatically selects the last sound field program used with the corresponding input source.
- Sound field programs cannot be selected when the component connected to the MULTI CH INPUT jacks is selected as the input source (see page 42).
- When you play back the Dolby TrueHD, Dolby Digital Plus, DTS-HD Master Audio, or DTS-HD High Resolution Audio sources, this unit does not activate any sound field program.
- When the sampling frequency of the input sources are higher than 96 kHz, this unit does not apply any sound field programs.

## Sound field program descriptions



Select a sound field program based on your listening preference, not merely on the name of the program, etc.

### ■ For audio music sources



For audio music sources, we also recommend that you use the Pure Direct mode (see page 51).

### Notes

- The available sound field parameters differ depending on the settings of the speakers.
- “DIALG.LIFT” is available only when “EXTRA SP ASSIGN” in “SPEAKER SET” is set to “PRESENCE” (see page 68).

### CLASSICAL

Program	Descriptions
Hall in Munich	This sound field simulates a concert hall with approximately 2500 seats in Munich, using stylish wood for the interior finishing as normal standards for European concert halls. Fine, beautiful reverberations spread richly, creating a calming atmosphere. The listener's virtual seat is at the center left of the arena.
Hall in Vienna	This is an approximately 1700-seated, middle-sized concert hall with a shoebox shape that is traditional in Vienna. Pillars and ornate carvings create extremely complex reflections from all around the audience, producing a very full, rich sound.
Chamber	This program creates a relatively wide space with a high ceiling like an audience hall in a palace. It offers pleasant reverberations that are suitable for courtly music and chamber music.

**LIVE/CLUB**

Program	Descriptions
Cellar Club	This program simulates a live house with a low ceiling and homey atmosphere. A realistic, live sound field features powerful sound as if the listener is in a row in front of a small stage.
The Roxy Theatre	This is the sound field of a rock music live house in Los Angeles, with approximately 460 seats. The listener's virtual seat is at the center left of the hall.
The Bottom Line	This is the sound field at stage front in The Bottom Line, that was a famous New York jazz club once. The floor can seat 300 people to the left and right in a sound field offering real and vibrant sound.

■ **For various sources**

**Notes**

- The available sound field parameters and the created sound fields differ depending on the input sources and the settings of this unit.
- "DIALG.LIFT" is available only when "EXTRA SP ASSIGN" in "SPEAKER SET" is set to "PRESENCE" (see page 68).

**ENTERTAINMENT**

Program	Descriptions
Sports	This program allows the listeners to enjoy stereo sport broadcasts and studio variety programs with enriched live feeling. In sports broadcasts, the voices of the commentator and sportscaster are positioned clearly at the center while the atmosphere of the stadium expands in an optimum space to offer the listeners with a feeling of presence in the stadium.
Action Game	This sound field has been suitable for action games such as car racing and FPS games. It uses the reflection data that limits the effects range per channel in order to offer a powerful playing environment with a being-there feeling by enhancing various effects tones while maintaining a clear sense of directions.
Roleplaying Game	This sound field has been suitable for role-playing and adventure games. It combines the sound field effects for movies and the sound field designs for "Action Game" to represent the depth and 3D feeling of the field during play, while offering movie-like surround effects in the movie scenes in the game.
Music Video	This sound field offers an image of a concert hall for live performance of pop, rock and jazz music. The listener can indulge oneself in a hot live space thanks to the presence sound field that emphasizes the vividness of vocals and solo play and the beat of rhythm instruments, and to the surround sound field that reproduces the space of a big live hall.

■ **For movie sources**



You can select the desired decoder used with following sound field program (except "Mono Movie"). See page 61 for details.

**Notes**

- The available sound field parameters and the created sound fields differ depending on the input sources and the settings of this unit.
- "DIALG.LIFT" is available only when "EXTRA SP ASSIGN" in "SPEAKER SET" is set to "PRESENCE" (see page 68).

**MOVIE**

Program	Descriptions
Standard	This program creates a sound field emphasizing the surrounding feeling without disturbing the original acoustic positioning of multi-channel audio such as Dolby Digital and DTS. It has been designed with the concept of "an ideal movie theater", in which the audience is surrounded by beautiful reverberations from the left, right and rear.
Spectacle	This program represents the spectacular feeling of large-scale movie productions. It reproduces a broad theater sound field matching the cinemascope and wider-screen movies with an excellent dynamic range from very small to extremely large sound.
Sci-Fi	This program clearly reproduces the finely elaborated sound design of the latest science fiction and special effects-featuring movies. You can enjoy a variety of cinematographically created virtual spaces reproduced with clear separation between dialog, sound effects and background music.

Program	Descriptions
Adventure	This program is ideal for precisely reproducing the sound design of action and adventure movies. The sound field restrains reverberations but puts emphasis on reproducing a powerful space expanded widely to the left and right. The reproduced depth is also restrained relatively to ensure the separation between audio channels and the clarity of the sound.
Drama	This sound field features stable reverberations that match a wide range of movie genres from serious dramas to musicals and comedies. The reverberations are modest but offer an optimum 3D feeling, reproducing effects tones and background music softly but cubically around clear words and center positioning in a way that does not fatigue the listener even after long hours of viewing.
Mono Movie	This program is provided for reproducing monaural video sources such as a classic movie in an atmosphere of a good old movie theater. The program produces the optimum expansion and reverberation to the original audio to create a comfortable space with a certain sound depth.

**Note**

The available parameters differ depending on the input sources and the settings of this unit.

**STEREO**

Program	Descriptions
2ch Stereo	Use this program to mix down multi-channel sources to 2 channels.
7ch Stereo	Use this program to output sound from all speakers. When you play back multi-channel sources, this unit downmixes the source to 2 channels, and then outputs the sound from all speakers. This program creates a larger sound field and is ideal for background music at parties, etc.

## ■ The Compressed Music Enhancer

**MUSIC ENHANCER**

Program	Descriptions
Straight Enhancer	Use this program to enhance the sound nearest to the original depth and width of the 2-channel or multi-channel compression artifacts.
7ch Enhancer	Use this program to play back compression artifacts in 7-channel stereo.

## ■ Surround decode mode

**SUR. DECODE**

Program	Descriptions
Sur. Decoder	Select this program to playback sources with selected decoders. You can playback 2-channel sources on multi-channels. See page 61 for details.

■ **Using sound field programs without surround speakers (Virtual CINEMA DSP)**

Virtual CINEMA DSP allows you to enjoy the CINEMA DSP programs without surround speakers. It creates virtual speakers to reproduce the natural sound field. When you set “SUR. L/R SP” to “NONE” (see page 69), Virtual CINEMA DSP activates automatically whenever you select a sound field program (see page 47).

**Note**

Virtual CINEMA DSP will not activate even when “SUR. L/R SP” is set to “NONE” (see page 69) in the following cases:

- when the component connected to the MULTI CH INPUT jacks is selected as the input source (see page 42).
- when headphones are connected to the PHONES jack.
- when this unit is in the “7ch Stereo” mode.

■ **Enjoying multi-channel sources and sound field programs with headphones (SILENT CINEMA)**

SILENT CINEMA allows you to enjoy multi-channel music or movie sound, including Dolby Digital and DTS sources, through ordinary headphones. SILENT CINEMA activates automatically whenever you connect headphones to the PHONES jack while listening to sound field programs (see page 47). When activated, the SILENT CINEMA indicator lights up in the front panel display.

**Notes**

- SILENT CINEMA does not activate when the component connected to the MULTI CH INPUT jacks is selected as the input source (see page 42).
- SILENT CINEMA is not effective when the “Pure Direct” (see page 51) or “2ch Stereo” mode (see page 49) is selected, or when this unit is in the “Straight” mode (see page 50).

Before performing the following operation, set the operation mode selector on the remote control to **AMP**.

**Enjoying unprocessed input sources (Straight decoding mode)**

When this unit is in the “Straight” mode, 2-channel stereo sources are output from only the front left and right speakers. Multi-channel sources are decoded straight into the appropriate channels without any additional effect processing.

---

**Press **STRAIGHT** (or **STRAIGHT**) to select “Straight”.**

■ **Deactivating the “Straight” mode**

---

**Press **STRAIGHT** (or **STRAIGHT**) so that “Straight” disappears from the front panel display.**

The sound effect is turned back on.

# Using audio features

Before performing the following operations, set the operation mode selector on the remote control to **AMP**.

## Adjusting the speaker level

You can adjust the output level of each speaker while listening to a music source. This is also possible when playing sources input at the MULTI CH INPUT jacks.

### Note

This operation will override the level adjustments made in “AUTO SETUP” (see page 31) and “SP LEVEL” (see page 70).

- 1 Press **LEVEL** on the remote control and then **▲ / ▼** repeatedly to select the speaker you want to adjust.

Display	Adjusted speaker
FRONT L	Front left speaker
FRONT R	Front right speaker
CENTER	Center speaker
SUR. L	Surround left speaker
SUR. R	Surround right speaker
SBL	Surround back left speaker
SBR	Surround back right speaker
SWFR	Subwoofer
FRNS L	Presence left speaker
FRNS R	Presence right speaker



- The available speaker channels differ depending on the setting of the speakers.
- When the video monitor is turned on, the “LEVEL” adjustment menu appears in the video monitor.

- 2 Press **◀ / ▶** to adjust the speaker output level.

- Press **▶** to increase the value.
  - Press **◀** to decrease the value.
- Control range: -10.0 dB to +10.0 dB

- 3 Press **LEVEL** to turn off the speaker level adjustment display.

## Enjoying pure hi-fi sound

Use the Pure Direct mode to enjoy the pure high fidelity sound of the selected source. When the Pure Direct mode is activated, this unit plays back the selected source with the least circuitry.

- Press **PURE DIRECT** (or **PURE DIRECT**) to turn the Pure Direct mode on or off.

The **PURE DIRECT** button on the front panel lights up while this unit is in the Pure Direct mode. The front panel display automatically dims.

### Notes

- The following operations are not possible when this unit is in the Pure Direct mode:
  - switching the sound field program
  - displaying the OSD
  - adjusting the “SET MENU” parameters (except for level settings)
  - operating video functions (video conversion, etc.)
- The Pure Direct mode is automatically canceled whenever this unit is turned off.



The front panel display turns on momentarily when an operation is performed.

## Adjusting the tonal quality

Use this feature to adjust the balance of bass and treble for the front left and right speaker channels.



Speaker and headphone adjustments are stored independently.

- 1 Press **TONE CONTROL** on the front panel repeatedly to select the high-frequency response (TREBLE) or the low-frequency response (BASS).

- 2 Rotate the **PROGRAM** selector to adjust the high-frequency response (TREBLE) or the low-frequency response (BASS).

Control range: -6 dB to +6 dB

### Notes

- If you increase or decrease the high-frequency or the low-frequency sound to an extreme level, the tonal quality of the surround speakers may not match.
- TONE CONTROL is not effective when PURE DIRECT is selected, or when MULTI CH INPUT is selected as the input source.

# Using iPod™

Once you have stationed your iPod in a Yamaha iPod universal dock (such as YDS-10, sold separately) connected to the DOCK terminal of this unit (see page 25), you can enjoy playback of your iPod using the supplied remote control. You can also use the Compressed Music Enhancer mode of this unit to improve the sound quality of the compression artifacts (such as the MP3 format) stored on your iPod (see page 49).

## Notes

- Only iPod (Click and Wheel), iPod nano, and iPod mini are supported.
- Some features may not be compatible depending on the model or the software version of your iPod.



- For a complete list of status messages that appear in the front panel display and in the OSD, see the “iPod” section in “Troubleshooting” on page 101.
- Once the connection between your iPod and this unit is complete, “iPod connected” appears in the front panel display and the DOCK indicator lights up in the front panel display.
- Only the analog audio and video signals of your iPod are input at the DOCK terminal, and the analog audio signals can be output at the analog AUDIO OUT (REC) jacks for recording.
- Your iPod battery is automatically charged when your iPod is stationed in a Yamaha iPod universal dock connected to the DOCK terminal of this unit as long as this unit is turned on. You can also select whether this unit charges the battery of the stationed iPod or not when this unit is in the standby mode by selecting the “STANDBY CHARGE” parameter in “INPUT MENU” (see page 77). The DOCK indicator turns on while this unit charges the battery of the connected iPod when this unit is in the standby mode.

## Controlling iPod™

You can control your iPod when “V-AUX” is selected as the input source. The operations of your iPod can be done with the aid of the OSD of this unit (menu browse mode) or without it (simple remote mode).

### ■ Remote control operation

Before performing the following operations, set the operation mode selector on the remote control to **⑩SOURCE** and then press **⑤V-AUX/DOCK**.

Button	Function
<b>⑨ ENTER</b>	Subsequent menu
	Menu up
	Menu down
	Previous menu
	Subsequent menu
<b>⑫</b>	Search backward (Press and hold)
	Search forward (Press and hold)
	Skip forward
	Skip backward
	Stop
	Pause (Menu browse mode) Play/Pause (Simple remote mode)
	Play (Menu browse mode) Play/Pause (Simple remote mode)
<b>⑮ MENU</b>	Previous menu
<b>⑳ DISPLAY</b>	Display

### ■ Controlling iPod in the simple remote mode

You can perform the basic operations of your iPod (play, stop, skip, etc.) using the supplied remote control without the aid of the OSD of this unit.



- You can view the photos or video clips stored on your iPod (some models only).
- Operations can be also done with the controls on your iPod.

## ■ Controlling iPod in the menu browse mode

You can perform the advanced operations of your iPod using the supplied remote control with the aid of the OSD of this unit. You can browse the songs stored on your iPod in the OSD. Further, you can change or adjust settings for your iPod to suit your personal preferences.



- The name of the song being played also appears in the front panel display according to the “FL SCROLL” parameter in “OPTION MENU” (see page 79).
- You can select the amount of time the iPod menu and play information is displayed in the OSD by using the “OSD-SOURCE” in “OPTION MENU” (see page 79).

### Notes

- Operations cannot be done with the controls on your iPod.
- There are some characters that cannot be displayed in the front panel display or in the OSD of this unit. Those characters are replaced with underscores “\_”.
- The “Settings” parameters can be changed or adjusted only in the OSD. Press **ENTER** or **Δ / ▽** repeatedly on the remote control to toggle between the “Settings” parameter settings.
- You cannot browse the photos or video clips stored on your iPod in the OSD. Use the simple remote mode to enjoy watching the photos or video clips stored on your iPod.

### 1 Set the operation mode selector to **SOURCE** and then press **DISPLAY** on the remote control.

The following display appears in the OSD.



### 2 Press **Δ / ▽ / < / >** to navigate the iPod menu and then press **ENTER** to begin playback of the selected song.

Choices: Playlists (playlists), Artists (artists), Albums (albums), Songs (songs), Genres (genres), Composers (composers), Settings (settings)

- Playlists > Songs
- Artists > Albums > Songs
- Albums > Songs
- Songs
- Genres > Artists > Albums > Songs
- Composers > Albums > Songs
- Settings > Shuffle, Repeat

### Shuffle Shuffle

Use this feature to set this unit to play songs or albums in random order.

Choices: Off, Songs, Albums

- Select “Off” to deactivate this feature.
- Select “Songs” to set this unit to play songs in random order.
- Select “Albums” to set this unit to play albums in random order.



When “Shuffle” is set to a setting other than “Off”, “” appears in the top right corner while songs or albums are being shuffled.

### Repeat Repeat

Use this feature to set this unit to repeat one song or a sequence of songs.

Choices: Off, One, All

- Select “Off” to deactivate this feature.
- Select “One” to set this unit to repeat one song.
- Select “All” to set this unit to repeat a sequence of songs.



When “Repeat” is set to a setting other than “Off”, “” or “” appears in the top right corner while one song or a sequence of songs are being repeated.

## ■ The function of the play information display



- [1] Playback status
- [2] Track number/total tracks
- [3] Artist name
- [4] Song title
- [5] Progress bar
- [6] Elapsed time
- [7] Shuffle and repeat icons
- [8] **▶** (playback), **||** (pausing), **▶▶** (search forward) and **◀◀** (search backward)
- [9] Name of the album
- [10] Remaining time

# Using Bluetooth™ components

You can connect a Yamaha Bluetooth adapter (such as YBA-10, sold separately) to the DOCK terminal of this unit and enjoy the music contents stored in your Bluetooth component (such as a portable music player) without wiring between this unit and the Bluetooth component. You need to perform “pairing” the connected Bluetooth adapter and your Bluetooth component in advance.

## Pairing the Bluetooth™ adapter and your Bluetooth™ component

Pairing must be performed when using a Bluetooth component with the Bluetooth adapter connected to this unit for the first time or if the pairing data has been deleted. “Pairing” refers to the operation of registering a Bluetooth component for Bluetooth communications.



- You only need the pairing operation for the first time that you use the Bluetooth component with the Bluetooth adapter.
- Pairing requires operations on this unit and on the other component with which Bluetooth communications are to be established. If necessary, refer to the other component’s operating instructions.

There are two pairing methods: pairing by using “START PAIRING” in “SET MENU” and quick pairing. See page 78 for details.

### ■ Pairing by using “SET MENU”

Use this feature to perform pairing with the video monitor. Select “START PAIRING” in “INPUT MENU”.

### ■ Quick pairing

To ensure security, a time limit of 8 minutes is set for the pairing operation. You are recommended to read and fully understand all the instructions before starting.

**1** Press **Ⓟ V-AUX/DOCK** to select “V-AUX” as the input source.

**2** Turn on the Bluetooth component you want to pair with.

**3** Press and hold **Ⓢ BAND** for 3 seconds to start pairing.

Once the Bluetooth adapter starts pairing, “Searching...” appears for a moment. While the Bluetooth adapter is in the pairing mode, DOCK indicator flashes in the front panel display.



To cancel the pairing, press **Ⓢ BAND** again.

### Note

If the Bluetooth adapter is not connected to the DOCK terminal of this unit, “No BT adapter” appears in the front panel display.

**4** Check that the Bluetooth component detects the Bluetooth adapter.

If the Bluetooth component detects the Bluetooth adapter, “YBA-10 YAMAHA” (example) appears in the Bluetooth device list.

**5** Select the Bluetooth adapter in the Bluetooth device list and then enter the pass key “0000” on the Bluetooth component.

When the pairing procedure is successful, “Completed” appears in the front panel display.

### Note

The Yamaha Bluetooth adapter can be paired with up to eight Bluetooth components. When pairing is conducted successfully with a ninth component and the pairing data is registered, the pairing data for the least recently used other component is cleared.

## Playback of the Bluetooth™ component

**1** Rotate the **Ⓛ INPUT** selector (or set the operation mode selector to **Ⓢ SOURCE** and then press **Ⓟ V-AUX/DOCK**) to select “V-AUX” as the input source.

**2** Start playback of your Bluetooth component.

When the connected Bluetooth adapter detects the Bluetooth component, “BT connected” and the DOCK indicator appears in the front panel display.



- When you press **Ⓢ ENTER** on the remote control, the connected Bluetooth adapter searches and connect to the last connected Bluetooth component. If the Bluetooth adapter cannot find the Bluetooth component, “Not found” appears in the front panel display.
- To disconnect the Bluetooth adapter from the Bluetooth component, press **Ⓢ RETURN**.



# Recording

Recording adjustments and other operations are performed from the recording components. Refer to the operating instructions for those components.

## Caution

The DTS signal is a digital bitstream. Attempting to digitally record the DTS bitstream will result in noise being recorded. Therefore, if you want to use this unit to record sources encoded in DTS, the following considerations and adjustments need to be made. To play DTS-encoded DVDs and CDs (when using a digital audio connection) on your DTS-compatible player, follow its operating instructions to make a setting so that the analog signal will be output from the player.

## Notes

- When this unit is set to the standby mode, you cannot record between other components connected to this unit.
- TONE CONTROL (see page 51) and VOLUME settings, the speaker level (see page 51) and the sound field programs (see page 47) do not affect recorded material.
- The source connected to the MULTI CH INPUT jacks of this unit cannot be recorded.
- Digital signals input at the DIGITAL INPUT jacks are not output at the analog AUDIO OUT (REC) jacks for recording. Likewise, analog signals input at the AUDIO IN jacks are not output at the DIGITAL OUTPUT jack. Therefore, if your source component is connected to provide only digital or analog signals, you can only record digital or analog signals.
- A given input source is not output on the same AUDIO OUT (REC) channel.
- S-video and composite video signals pass independently through the video circuits of this unit. Therefore, when recording or dubbing video signals input from a video source component that provides only an S-video or a composite video signal, you can only record an S-video or a composite video signal on your VCR.
- The analog audio signals input at the DOCK terminal can be output at the analog AUDIO OUT (REC) jacks for recording.
- Check the copyright laws in your country to record from CDs, radio, etc. Recording of copyrighted material may infringe copyright laws.



Do a test recording before you start an actual recording.

If you play back a video source that uses scrambled or encoded signals to prevent it from being dubbed, the picture itself may be disturbed due to those signals.

**1 Turn on all the connected components.**

**2 Rotate the ①INPUT selector (or press one of the input selector buttons (⑤)) to select the source component you want to record from.**

**3 Start playback on the selected source component or select a broadcast station.**

**4 Start recording on the recording component.**

# Advanced sound configurations

## Changing sound field parameter settings

You can enjoy good quality sound with the initial factory settings. Although you do not have to change the initial factory settings, you can change some of the parameters to better suit the input source or your listening room.

### Note

You cannot change the sound field parameter values when “MEMORY GUARD” in “OPTION MENU” is set to “ON” (see page 80). If you want to change the sound field parameter values, set “MEMORY GUARD” to “OFF”.

**1 Turn on the video monitor connected to this unit.**

**2 Set the operation mode selector to **AMP** and then press **PARAMETER** on the remote control.**

The following screen is shown in the OSD.

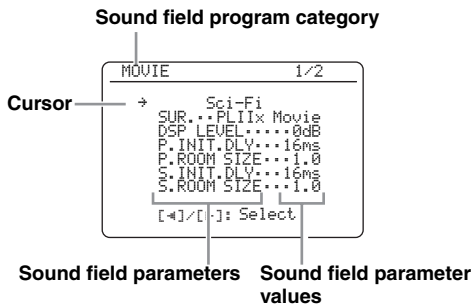

**3 Press one of the sound field program selector buttons (**28**) repeatedly to select the desired sound field program you want to adjust.**

**4 Press **Δ** / **∇** to select the desired sound field parameter and then **◀** / **▶** to change the selected sound field parameter value.**

- Press **▶** to increase the value.
- Press **◀** to decrease the value.



- For details about the function and control range of each sound field parameter, see page 58.
- When you set a sound field parameter to a value other than the initial factory settings, an asterisk mark (\*) appears by the sound field parameter name in the OSD.
- Repeat steps 3 and 4 as necessary to change other sound field program parameter settings.
- The available sound field parameters for some of the sound field programs may be displayed on more than one page in the OSD. In this case, press **Δ** / **∇** to scroll through pages.
- To initialize the parameters of the selected sound field program, press **∇** repeatedly to select “INITIALIZE” and then press **▶**. Once the confirmation screen appears in the OSD, press **▶**. To confirm or **◀** to cancel the initialization.

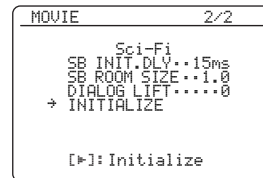

**5 Press **PARAMETER** to turn off the sound field parameter screen.**

## ■ Basic configuration of sound field programs

Each sound field program has some parameters defining the characteristics of the program. To customize the selected sound field program, adjust “DSP LEVEL” and/or “DIALG.LIFT” first, and then try other parameters.



To change sound field parameter settings, see page 56 for details.

### Adjusting the effect sound level of the sound field programs (DSP LEVEL)

Sound field programs add effect sounds (DSP effect sounds) to the original source sound to create sound field in the listening room. Use the “DSP LEVEL” parameter to adjust the level of the effect sounds.

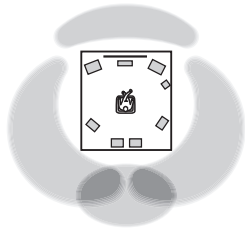

The DSP effect sound level is low.

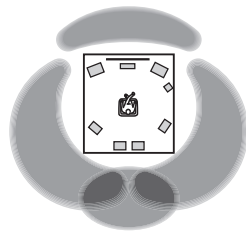

The DSP effect sound level is high.

Adjust “DSP LEVEL” in the following cases:

#### Increase the value of “DSP LEVEL”

- The effect sound of the selected sound field program is too weak.
- You cannot recognize any difference between the sound field programs.

#### Decrease the value of “DSP LEVEL”

- The sound is vague.
- You feel that the additional sound effect is excessive.

Control range: -6 dB to +3 dB

### Adjusting the vertical dialogue position (DIALG.LIFT)

Use this feature to adjust the vertical position of the dialogues in movies. The ideal position of the dialogues is at the center of the video monitor screen.

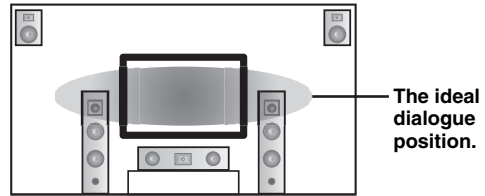

If the dialogues are heard at the lower position of the video monitor screen, increase the value of “DIALG.LIFT”.

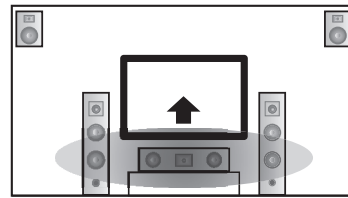

Move up to the ideal dialogue position.

Choices: 0, 1, 2, 3, 4, 5

“0” (initial setting) is the lowest position, and “5” is the highest position.

#### Notes

- “DIALG.LIFT” is only available only “EXTRA SP ASSIGN” is set to “PRESENCE” (see page 68).
- You cannot move the dialogue position down from the initial dialogue position.

## ■ Sound field parameters for the advanced configurations

Use the following sound field parameters to customize sound field programs in detail.



To change sound field parameter settings, see page 56 for details.

Sound field parameter	Features
INIT.DLY P. INIT.DLY S. INIT.DLY SB INI.DLY	<p>Initial delay. Presence, surround, and surround back sound field initial delay. Changes the apparent distance from the source sound by adjusting the delay between the direct sound and the first reflection heard by the listener. The smaller the value, the closer the sound source seems to the reflection face.</p> <p> When you adjust the initial delay parameters, we also recommend that you adjust the corresponding room size parameters likewise. This adjustment is especially effective for the CINEMA DSP programs.</p> <hr/> <p>Control range: 1 to 99 ms (INIT.DLY and P.INIT.DLY) 1 to 49 ms (S.INIT.DLY and SB INI.DLY)</p>

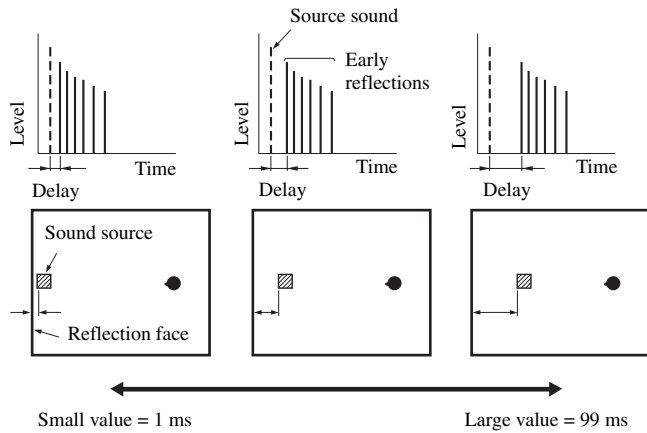

Sound field parameter	Features
-----------------------	----------

ROOM SIZE  
 P.ROOM SIZE  
 S.ROOM SIZE  
 SB ROOM SIZE

Room size. Presence, surround, and surround back room size. Adjusts the apparent size of the surround sound field. The larger the value, the larger the surround sound field becomes. As the sound is repeatedly reflected around a room, the larger the hall is, the longer the time between the original reflected sound and the subsequent reflections. By controlling the time between the reflected sounds, you can change the apparent size of the virtual venue. Changing this parameter from one to two doubles the apparent length of the room.



When you adjust the room size parameters, we also recommend that you adjust the corresponding initial delay parameters likewise. This adjustment is especially effective for the CINEMA DSP programs.

Control range: 0.1 to 2.0

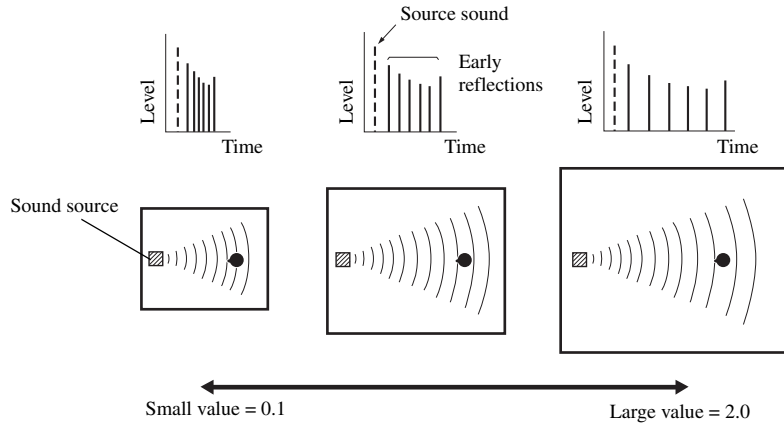

LIVENESS  
 S.LIVENESS  
 SB LIVENESS

Liveness. Surround and surround back sound field liveness. Adjusts the reflectivity of the virtual walls in the hall by changing the rate at which the early reflections decay. The early reflections of a sound source decay much faster in a room with acoustically absorbent wall surfaces than in one which has highly reflective surfaces. A room with acoustically absorbent surfaces is referred to as “dead”, while a room with highly reflective surfaces is referred to as “live”. This parameter lets you adjust the early reflection decay rate and thus the “liveness” of the room.

Control range: 0 to 10

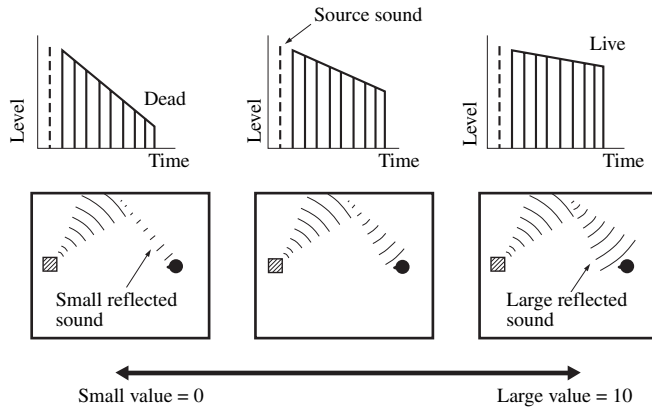

Sound field parameter	Features
-----------------------	----------

REV.TIME

Reverberation time. Adjusts the amount of time taken for the dense, subsequent reverberation sound to decay by 60 dB at 1 kHz. This changes the apparent size of the acoustic environment over an extremely wide range. Set a longer reverberation time for “dead” sources and listening room environments, and a shorter time for “live” sources and listening room environments.

Control range: 1.0 to 5.0 s

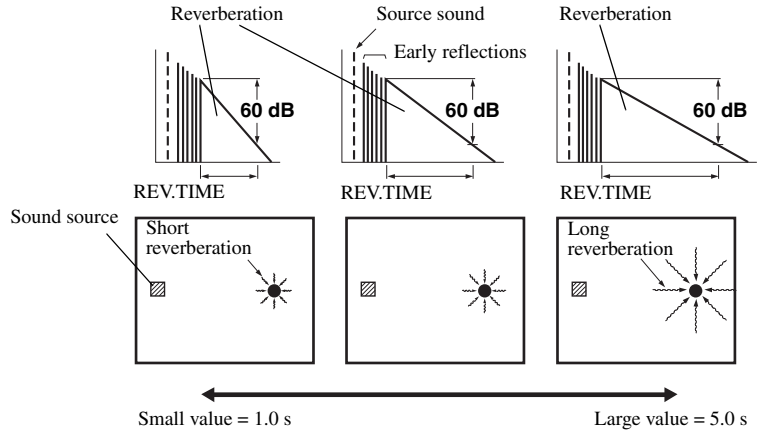

REV.DELAY

Reverberation delay. Adjusts the time difference between the beginning of the direct sound and the beginning of the reverberation sound. The larger the value, the later the reverberation sound begins. A later reverberation sound makes you feel as if you are in a larger acoustic environment.

Control range: 0 to 250 ms

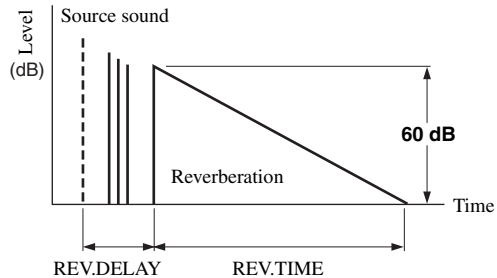

REV.LEVEL

Reverberation level. Adjusts the volume of the reverberation sound. The larger the value, the stronger the reverberation becomes.

Control range: 0 to 100%

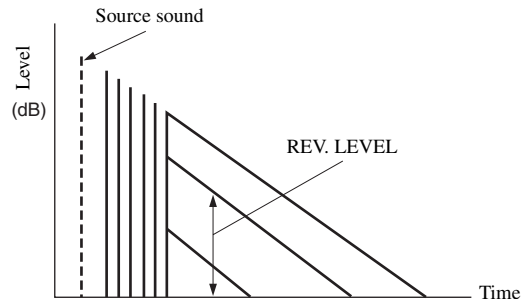

Sound field parameter	Features
DIRECT ("2ch Stereo" only)	<p>2-channel stereo direct. Bypasses the decoders and the DSP processors of this unit for pure hi-fi stereo sound when playing 2-channel analog sources.</p> <hr/> <p>Choices: <b>AUTO</b>, OFF</p> <hr/> <p></p> <ul style="list-style-type: none"> <li>• Select "AUTO" to bypass the decoders, the DSP processors and the tone control circuitry only when "BASS" and "TREBLE" are set to 0 dB (see page 51).</li> <li>• Select "OFF" not to bypass the decoders, the DSP processors and the tone control circuitry when "BASS" and "TREBLE" are set to 0 dB.</li> <li>• When multi-channel signals (Dolby Digital and DTS) are input, they are downmixed to 2 channels and output from the front left and right speakers.</li> <li>• The low-frequency signals of the front left and right channels are redirected to the subwoofer in the following cases: <ul style="list-style-type: none"> <li>– "LFE/BASS OUT" is set to "BOTH" (see page 68).</li> <li>– "FRONT SP" is set to "SMALL" (see page 69) and "LFE/BASS OUT" is set to "SWFR" (see page 68).</li> </ul> </li> </ul>
CT LEVEL SL LEVEL SR LEVEL SB LEVEL PL LEVEL PR LEVEL ("7ch Stereo" only)	<p>7-channel stereo center, surround left, surround right, surround back, presence left and presence right levels. Adjusts the volume level of each channel in the 7-channel stereo mode. The available parameters differ depending on the setting of the speakers.</p> <hr/> <p>Control range: 0 to 100%</p>
EFFECT LEVEL ("Straight Enhancer" and "7ch Enhancer" only)	<p>Straight and 7-channel Compressed Music Enhancer effect level. The high-frequency signals of some sources may be emphasized too much. In this case, set the effect level to "LOW".</p> <hr/> <p>Choices: <b>HIGH</b>, LOW</p> <hr/> <ul style="list-style-type: none"> <li>• Select "HIGH" for a high effect level.</li> <li>• Select "LOW" for a low effect level.</li> </ul>

## ■ Selecting decoders used with sound field programs (SUR.)

Use this feature to select the desired decoder used with MOVIE sound field programs (except "Mono Movie"). See page 48 for details about MOVIE sound field program.



### Available decoders

Decoder	Functions
PLIIx Movie PLII Movie	Dolby Pro Logic IIX (or Dolby Pro Logic II) processing for movie sources. The Pro Logic IIX decoder is not available when "SUR.B L/R SP" is set to "NONE" (see page 69).
Neo:6 Cinema	DTS processing for movie sources.

## Selecting decoders





### ■ Selecting decoders for 2-channel sources (surround decode mode)

Use this feature to play back sources with selected decoders. You can play back 2-channel sources on multi-channels.

**Set the operation mode selector to  AMP and then press  SUR. DECODE repeatedly on the remote control to select the desired surround decoder.**

You can select from the following modes depending on the type of source you are playing and your personal preference.



You can change the decoder parameter settings (see page 62). Set the operation mode to  AMP and then press  PARAMETER to display the decoder parameters in the OSD. Press  repeatedly to select the desired decoder parameter and then press  repeatedly to change the value of the selected parameter.

## ■ Decoder descriptions (SUR.)

Decoder	Descriptions
Pro Logic	Dolby Pro Logic processing for any sources.
PLIIx Movie PLII Movie	Dolby Pro Logic IIX (or Dolby Pro Logic II) processing for movie sources. The Pro Logic IIX decoder is not available when "SUR.B L/R SP" is set to "NONE" (see page 69).
PLIIx Music PLII Music	Dolby Pro Logic IIX (or Dolby Pro Logic II) processing for music sources. The Pro Logic IIX decoder is not available when "SUR.B L/R SP" is set to "NONE" (see page 69).
PLIIx Game PLII Game	Dolby Pro Logic IIX (or Dolby Pro Logic II) processing for game sources. The Pro Logic IIX decoder is not available when "SUR.B L/R SP" is set to "NONE" (see page 69).
Neo:6 Cinema	DTS processing for movie sources.
Neo:6 Music	DTS processing for music sources.



When you select the surround decode mode for Dolby Digital, DTS or DTS 96/24 sources, this unit automatically selects "SURROUND DECODE Dolby Digital", "SURROUND DECODE DTS" or "SURROUND DECODE DTS 96/24" program.

## Decoder parameter descriptions

Decoder parameter	Features
PANORAMA ( <b>"PLIIX Music"</b> and <b>"PLII Music"</b> only)	Pro Logic IIX Music and Pro Logic II Music panorama. Sends stereo signals to the surround speakers as well as the front speakers for a wraparound effect.  Choices: <b>OFF</b> , <b>ON</b>
DIMENSION ( <b>"PLIIX Music"</b> and <b>"PLII Music"</b> only)	Pro Logic IIX Music and Pro Logic II Music dimension. Adjusts the sound field either towards the front or towards the rear.  Control range: -3 (towards the rear) to +3 (towards the front)  Initial setting: STD (standard)
CENTER WIDTH ( <b>"PLIIX Music"</b> and <b>"PLII Music"</b> only)	Pro Logic IIX Music and Pro Logic II Music center width. Moves the center channel output completely towards the center speaker or towards the front left and right speakers. A larger value moves the center channel output towards the front left and right speakers.  Control range: 0 (center channel sound is output only from the center speaker) to 7 (center channel sound is output only from the front left and right speakers)  Initial setting: 3
C. IMAGE ( <b>"Neo:6 Music"</b> only)	DTS Neo:6 Music center image. Adjusts the front left and right channel output relative to the center channel to make the center channel more or less dominant as necessary.  Control range: 0.0 (center channel sound is output only from the front left and right speakers) to 1.0 (center channel sound output only from the center speaker)  Initial setting: 0.3



# Customizing this unit (MANUAL SETUP)

You can use the following parameters in “SET MENU” to adjust a variety of system settings and customize the way this unit operates. Change the initial settings (indicated in bold under each parameter) to reflect the needs of your listening environment.

## ■ Auto setup AUTO SETUP

Use this feature to automatically adjust speaker and system parameters (see page 31).

## ■ Manual setup MANUAL SETUP

Use this feature to manually adjust speaker and system parameters.

### Basic menu 1 BASIC MENU

Menu	Parameter	Functions	Page
A) SPEAKER SET	EXTRA SP ASSIGN	Selects the function of the speakers connected to the EXTRA SP speaker terminal.	68
	LFE/BASS OUT	Selects the speakers that output the LFE (low-frequency effect) and the low-frequency signals.	68
	FRONT SP	Selects the size of the front speakers.	69
	CENTER SP	Selects the size of the center speaker.	69
	SUR. L/R SP	Selects the size and number of the surround speakers.	69
	SUR. B L/R SP	Selects the size and number of the surround back speakers.	69
	CROSS OVER	Selects the crossover frequency of all the speakers set to “SML” (or “SMALL”) in “SPEAKER SET” (see page 69).	70
	SUBWOOFER PHASE	Switches the phase of your subwoofer if bass sounds are lacking or unclear.	70
B) SP LEVEL	FR. L/FR. R/CNTR/ SUR. L/SUR. R/ SBL/SBR/SWFR/ PR. L/PR. R	Adjust the balance the speaker levels between the front left or surround left speakers and each speaker selected in “SPEAKER SET” (see page 68).	70
C) SP DISTANCE	UNIT	Selects the unit to adjust the speaker distance.	71
	FRONT L/FRONT R/ CENTER/SUR. L/ SUR. R/SBL/SBR/ SWFR/PRNS L/ PRNS R	Adjust the distance of each speaker and the delay applied to the respective channel.	71
D) TEST TONE	—	Turns the test tone output on or off for the “SPEAKER SET”, “SP LEVEL”, and “SP DISTANCE” settings.	71

Volume menu 2 VOLUME MENU

Parameter	Functions	Page
ADAPTIVE DRC	Selects whether this unit automatically adjusts the dynamic range in conjunction with the volume level or not.	72
ADAPTIVE DSP LEVEL	Selects whether this unit adjusts the DSP effect level automatically in conjunction with the volume level or not.	72
MUTE TYPE	Adjusts how much the mute function reduces the output volume (see page 44).	72
MAX VOL.	Sets the maximum volume level of this unit.	72
INIT. VOL.	Sets the volume level of this unit when the power of this unit is turned on.	72

Sound menu 3 SOUND MENU

Menu	Parameter	Functions	Page
A)EQUALIZER	EQ TYPE SELECT	Selects the type of equalizer.	73
	GEQ	Adjusts the tonal quality of the speakers when you set "EQ TYPE SELECT" to "GEQ".	73
	TEST	Selects whether this unit outputs the test tone while making adjustments of "GEQ" or not.	73
B)LFE LEVEL	SPEAKER	Adjusts the speaker LFE level.	74
	HEADPHONE	Adjusts the headphone LFE level.	74
C)DYNAMIC RANGE	SPEAKER	Adjusts the amount of the dynamic range compression of the speakers.	74
	HEADPHONE	Adjusts the amount of the dynamic range compression of the headphones.	74
D)LIPSYNC	HDMI AUTO	Selects whether this unit activates the automatic audio and video synchronization function (automatic lip sync) or not.	75
	AUTO	Makes fine adjustments of the audio delay when the automatic audio and video synchronization function is active.	75
	MANUAL	Adjustment the audio delay manually when the connected video monitor is not compatible with the automatic audio and video synchronization function or "HDMI AUTO" is set to "OFF".	75
E)EXTD SUR.	—	Use this feature to enjoy 6.1/7.1-channel playback for multi-channel sources using the Dolby Pro Logic IIX, Dolby Digital EX, or DTS-ES decoders by using the connected surround back speakers.	75

## Input menu 4 INPUT MENU

**Note**

Some parameters described below may not be available for all input sources and some parameters are only available for specific input sources.

Parameter	Functions	Page
I/O ASSIGNMENT	Assigns the input/output jacks according to the component to be used if the initial settings of this unit do not correspond to your needs.	76
INPUT RENAME	Changes the name of the input source that appears in the OSD and in the front panel display.	77
VOL. TRIM	Adjusts the level of the signal input at each jack.	77
DECODER MODE	Switches the decoder activation mode. You can designate the reassigned digital input jacks for DTS signals.	77
STANDBY CHARGE	Selects whether this unit charges the battery of the stationed iPod or not when this unit is in the standby mode (see page 28).	77
START PAIRING	Pair the connected Yamaha Bluetooth adapter (such as YBA-10, sold separately) with a Bluetooth component (see page 54).	78
BGV	Selects the video source played back in the background of the sources input at the MULTI CH INPUT jacks.	78
INPUT CH	Selects the number of channels input from an external decoder.	78
FRONT	Selects the analog jacks at which the front channel signals from an external decoder are input when you set "INPUT CH" to "8CH".	78

## Option menu 5 OPTION MENU

Menu	Parameter	Functions	Page
A)DISPLAY SET	DIMMER	Adjusts the brightness of the front panel display.	79
	OSD SHIFT	Adjusts the vertical position of the OSD.	79
	OSD-SOURCE	Sets the amount of time to display the iPod menu in the video monitor after you perform a certain operation.	79
	OSD-AMP	Sets the amount of time to display the status information screen after you perform a certain operation.	79
	FL SCROLL	Selects the mode to display the information of the iPod in the front panel display.	79
B)VIDEO SET	VIDEO CONV.	Selects whether to convert the video signals input at the VIDEO, S VIDEO, and COMPONENT VIDEO jacks.	80
C)MEMORY GUARD	—	Prevents accidental changes to sound field program parameter values and other system settings.	80

Menu	Parameter	Functions	Page
D>INIT. CONFIG	AUDIO SELECT	Designates the default audio input jack select setting for the input sources connected to the DIGITAL INPUT jacks when you turn on the power of this unit.	81
	DECODER MODE	Designates the default decoder mode for the input sources connected to the DIGITAL INPUT jacks when you turn on the power of this unit.	81
	EXTD SUR.	Designates the extended decoder mode for the input sources connected to the DIGITAL INPUT jacks when you turn on the power of this unit.	81
E>HDMI SET	S.AUDIO	Selects whether to play back HDMI audio signals on this unit or on another HDMI component connected to the HDMI OUT jack.	81

■ **Signal information** SIGNAL INFO

Use this feature to check audio and video signal information (see page 45).

## Using SET MENU

Use the remote control to access and adjust each parameter.



- You can change the “SET MENU” parameters while this unit is reproducing sound.
- If you press **PARAMETER** during the “SET MENU” operation, the “SET MENU” operation is canceled.
- Press **RETURN** to return to the previous menu level.

### 1 Set the operation mode selector to **AMP** and then press **SET MENU** to enter “SET MENU”.

The top “SET MENU” display appears in the OSD.

### 2 Press **△/▽** to select “MANUAL SETUP”.

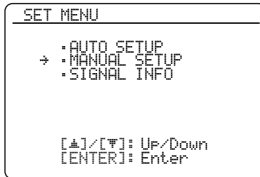

### 3 Press **ENTER** to enter “MANUAL SETUP”.

The “MANUAL SETUP” display appears in the OSD.

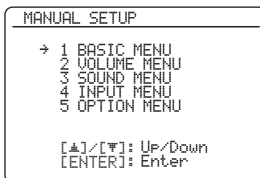

### 4 Press **△/▽** repeatedly and then press **ENTER** to select and enter the desired menu.

The following displays are examples where “SOUND MENU” is selected.

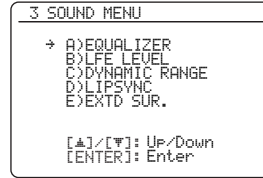

### 5 Press **△/▽** repeatedly and then press **ENTER** to select and enter the desired submenu.

The following display is an example where “LFE LEVEL” is selected.

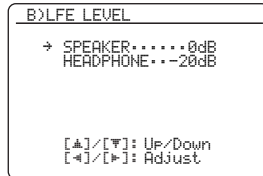

### 6 Press **△/▽** to select the desired parameter and then **◀/▶** to change the parameter settings.

- Press **▶** to increase the value.
- Press **◀** to decrease the value.

### 7 Press **SET MENU** to exit from “SET MENU”.

# 1 BASIC MENU

Use this feature to manually adjust the basic speaker settings. Most of the “BASIC MENU” parameters are set automatically when you run the automatic setup.



Set “TEST TONE” to “ON” to output the test tone for the “SPEAKER SET”, “SP LEVEL” and “SP DISTANCE”.

## ■ Speaker settings A>SPEAKER SET



To select the desired parameter, press **⊕** / **⊖** repeatedly.

### Extra speaker assignment EXTRA SP ASSIGN

Selects the function of the speakers connected to the EXTRA SP terminals.



Choice	Descriptions
<b>FRONT B</b>	Select this setting when you use another front speaker system in the main room (see page 42).
<b>ZONE B</b>	Select this setting when you use another front speaker system in another room (see page 42).
<b>PRESENCE</b>	Select this setting when you use the presence speakers (see page 13).
<b>NONE</b>	Select this setting when you do not use the EXTRA SP terminals.

### Notes

- This parameter shares the value with the “EXTRA SP ASSIGN” parameter in “AUTO SETUP” (see page 32).
- If you select “ON” in “BI-AMP” (see page 96), you cannot select “PRESENCE” in “EXTRA SP ASSIGN”.
- After changing the “EXTRA SP ASSIGN” setting, carry out “AUTO SETUP” again (see page 31).

## LFE/bass out LFE/BASS OUT

Use this feature to select the speakers that output the LFE (low-frequency effect) and the low-frequency signals.

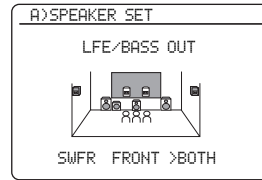

### LFE signals output

Choice	Subwoofer(s) and speakers		
	Subwoofer(s)	Front speakers	Other speakers
<b>BOTH</b>	Output	No output	No output
<b>SWFR</b>	Output	No output	No output
<b>FRONT</b>	No output	Output	No output

### Low-frequency signals output

Choice	Subwoofer(s) and speakers		
	Subwoofer(s)	Front speakers	Other speakers
<b>BOTH</b>	*1	*2	*3
<b>SWFR</b>	*4	*3	*3
<b>FRONT</b>	No output	*1	*3

- \*1 Output(s) the low-frequency signals of the front channels and other speakers set to “SMALL”.
- \*2 Always output the low-frequency signals of the front channels.
- \*3 Output the low-frequency signals if the speakers are set to “LARGE”.
- \*4 Outputs the low-frequency signals of the speakers set to “SMALL” or “NONE”.

**Measure for the speaker size**

The woofer section of a speaker is

- 16 cm (6.5 in) or larger: large
- smaller than 16 cm (6.5 in): small

**Front speakers FRONT SP**

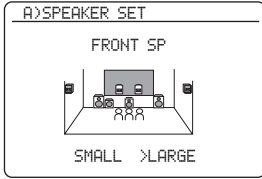

Choice	Descriptions
<b>LARGE</b>	Select this setting when the front speakers are large.
<b>SMALL</b>	Select this setting when the front speakers are small.

**Note**

When "LFE/BASS OUT" is set to "FRONT", you can select only "LARGE" in "FRONT SP". If the value of "FRONT SP" is set to other than "LARGE" in advance, this unit change the value to "LARGE" automatically.

**Center speaker CENTER SP**

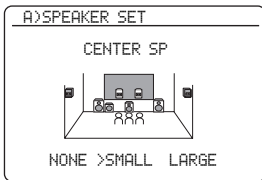

**When the center speaker is large:**

Select "LARGE" (large).

**When the center speaker is small:**

Select "SMALL" (small).

**When you do not use the center speaker:**

Select "NONE" (none). The center channel signals are directed to the front left and right speakers.

Choice	Descriptions
<b>LARGE</b>	Select this setting when the center speaker is large.
<b>SMALL</b>	Select this setting when the center speaker is small.
<b>NONE</b>	Select this setting when you do not use the center speaker. The center channel signals are directed to the front left and right speakers.

**Surround left/right speakers SUR. L/R SP**

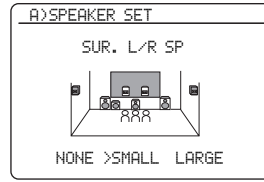

Choice	Descriptions
<b>LARGE</b>	Select this setting when the surround speakers are large.
<b>SMALL</b>	Select this setting when the surround speakers are small.
<b>NONE</b>	Select this setting when you do not use the surround speakers. This unit is set to the Virtual CINEMA DSP mode (see page 50), and "SUR.B L/R SP" is automatically set to "NONE".

**Surround back left/right speakers**

**SUR.B L/R SP**

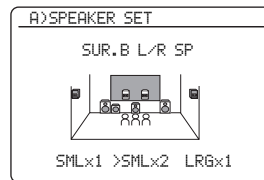

Choice	Descriptions
<b>LRGx1</b>	Select this setting when the single surround back speaker is large.
<b>LRGx2</b>	Select this setting when the surround back left and right speakers are Large.
<b>SMLx1</b>	Select this setting when the single surround back speaker is small.
<b>SMLx2</b>	Select this setting when the surround back left and right speakers are small.
<b>NONE</b>	Select this setting when you do not use the surround back speakers. The surround back channel signals are directed to the surround left and right speakers.

**Note**

If the Dolby TrueHD audio signals are input and "SUR.B L/R SP" is set to "NONE", the left and right surround back channels are not directed to the surround left and right speakers.

**Bass cross over** CROSS OVER

Use this feature to select the crossover frequency of all the speakers set to “SML” (or “SMALL”) in “SPEAKER SET” (see page 68). All frequencies below the selected frequency will be sent to the subwoofer(s) or front speakers depending on the setting of “LFE/BASS OUT” in “SPEAKER SET” (see page 68).

Choices: 40Hz, 60Hz, **80Hz**, 90Hz, 100Hz, 110Hz, 120Hz, 160Hz, 200Hz



If your subwoofer can adjust the output volume and the crossover frequency, set the volume to about half way (or slightly less) and set the crossover frequency to the maximum.

**Subwoofer phase** SUBWOOFER PHASE

Use this feature to switch the phase of your subwoofer if bass sounds are lacking or unclear.

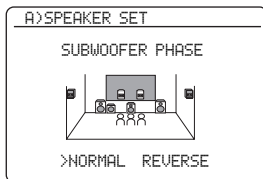

Choice	Functions
<b>NORMAL</b> (normal)	Does not change the phase of your subwoofer.
REVERSE (reverse)	Sets the phase of your subwoofer to reverse.

■ **Speaker level** B>SP LEVEL

Use this feature to manually balance the speaker levels between the front left or surround left speakers and each speaker selected in “SPEAKER SET” (see page 68).

Control range: -10.0 dB to +10.0 dB

Control step: 0.5 dB

Initial setting:

FR.L/FR.R/SWFR/PR.L/PR.R: 0 dB

CNTR/SUR.L/SUR.R/SBL/SBR: -1.0 dB

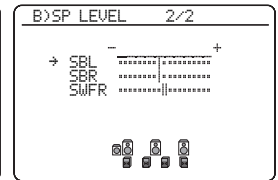
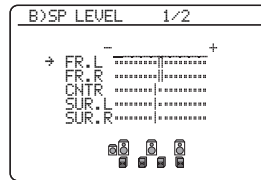

SP LEVEL	Adjusted speaker
FR.L	Front left speaker
FR.R	Front right speaker
CNTR	Center speaker
SUR.L	Surround left speaker
SUR.R	Surround right speaker
SBL	Surround back left speaker
SBR	Surround back right speaker
SWFR	Subwoofer
PR.L	Presence left speaker
PR.R	Presence right speaker



- If your subwoofer can adjust the output volume and the crossover frequency, set the volume to about half way (or slightly less) and set the crossover frequency to the maximum.
- Set “TEST TONE” to “ON” to output the test tone for the “SPEAKER LEVEL” setting (see page 71).

**Notes**

- The available speaker channels differ depending on the setting of the speakers.
- Instead of “SBL” and “SBR”, “SB” is displayed if “SUR. B L/R SP” is set to either “SMLx1” or “LRGx1” (see page 69).



**Speaker distance** C)SP DISTANCE

Use this feature to manually adjust the distance of each speaker and the delay applied to the respective channel. Ideally, each speaker should be the same distance from the main listening position. However, this is not possible in most home situations. Thus, a certain amount of delay must be applied to the sound from each speaker so that all sounds will arrive at the listening position at the same time.

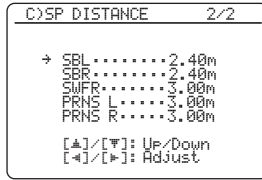
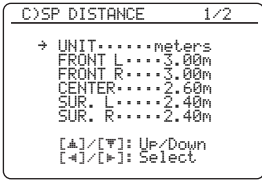

**Unit for the speaker distance adjustment** UNIT

Choice	Functions
meters (m)	Adjusts speaker distances in meters.
feet (ft)	Adjusts speaker distances in feet.

**Speaker distances**

Control range: 0.30 to 24.00 m (1.0 to 80.0 ft)

Control step: 0.10 m (0.5 ft)

Initial setting:

FRONT L/FRONT R/SWFR/PRNS L/

PRNS R: 3.00 m (10.0 ft)

CENTER: 2.60 m (8.5 ft)

SUR. L/SUR. R/SBL/SBR: 2.40 m (8.0 ft)

SP DISTANCE	Adjusted speaker
FRONT L	Front left speaker
FRONT R	Front right speaker
CENTER	Center speaker
SUR. L	Surround left speaker
SUR. R	Surround right speaker
SBL	Surround back left speaker
SBR	Surround back right speaker
SWFR	Subwoofer
PRNS L	Presence left speaker
PRNS R	Presence right speaker

**Notes**

- The available speaker channels differ depending on the setting of the speakers.
- Instead of “SBL” and “SBR”, “SUR.B” is displayed if “SUR.B L/R SP” is set to either “SMLx1” or “LRGx1” (see page 69).

**Test tone** D)TEST TONE

Turns the test tone output on or off for the “SPEAKER

SET”, “SP LEVEL”, and “SP DISTANCE” settings.

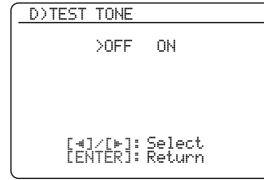

Choice	Functions
OFF	This unit does not output the test tone for the “SPEAKER SET”, “SP LEVEL”, and “SP DISTANCE” settings.
ON	This unit outputs the test tone for the “SPEAKER SET”, “SP LEVEL”, and “SP DISTANCE” settings.



If you use a handheld sound pressure level meter, hold at arm’s length and point upwards so that the meter is in the listening position. With the meter set to the 70 dB scale and to C SLOW, calibrate each speaker to 75 dB.

**Note**

This function is automatically turned off if you exit from “BASIC MENU”.

## 2 VOLUME MENU

Use this menu to manually adjust the various volume settings.

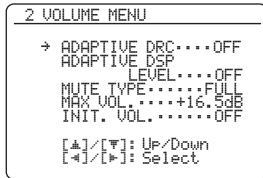

### Adaptive dynamic range control

#### ADAPTIVE DRC

Use this feature to adjust the dynamic range in conjunction with the volume level. This feature is useful when you are listening at lower volumes or at night. When “ADAPTIVE DRC” is set to “AUTO”, this unit controls the dynamic range as follows:

- If the VOLUME setting is low: the dynamic range is narrow
- If the VOLUME setting is high: the dynamic range is wide

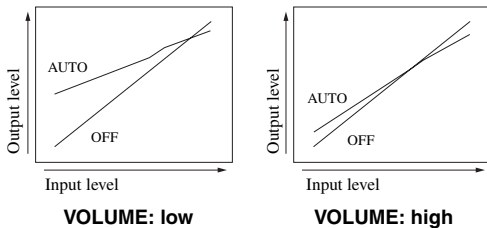

Choice	Functions
AUTO	Adjusts the dynamic range automatically.
OFF	Does not adjust the dynamic range automatically.



- You can also adjust the dynamic range of the bitstream signal sources by using “DYNAMIC RANGE” in “SOUND MENU” (see page 74).
- This function is also useful for listening with your headphones.

#### Note

The adaptive dynamic range control feature does not function when this unit is in the Pure Direct mode (see page 51).

### Adaptive DSP level ADAPTIVE DSP LEVEL

Use this feature to make fine adjustments of the DSP effect level (see page 57) automatically in conjunction with the volume level.

Choice	Functions
AUTO	Adjusts the DSP effect level in conjunction with the volume level.
OFF	Does not adjust the DSP effect level automatically.

#### Note

Even if you set “ADAPTIVE DSP LEVEL” to “AUTO”, this unit does not change but the fine-tunes the specified value of “DSP LEVEL” (see page 57).

### Muting type MUTE TYPE

Use this feature to adjust how much the mute function reduces the output volume (see page 44).

Choice	Functions
FULL	Mutes all the audio output.
-20dB	Reduces the current volume by 20 dB.

### Maximum volume MAX VOL.

Use this feature to set the maximum volume level. This feature is useful to avoid the unexpected loud sound by mistake. For example, the original volume range is -80.0 dB to +16.5 dB. However, when “MAX VOL.” is set to -5.0 dB, the volume range becomes -80.0 dB to -5.0 dB.

Control range: -30.0 dB to +15.0 dB, **+16.5 dB**

Control step: 5.0 dB

#### Notes

- When this unit is in the auto setup procedure, the volume level is automatically set to 0 dB regardless of the current “MAX VOL.” setting.
- The “MAX VOL.” setting takes priority over the initial volume setting. For example, if “INI.VOL.” is set to -20.0 dB and “MAX VOL.” is set to -30.0 dB, the volume level is automatically set to -30.0 dB when you turn on the power of this unit next time.

### Initial volume INIT. VOL.

Use this feature to set the volume level of this unit when the power of this unit is turned on.

Choices: **OFF**, MUTE, -80.0 dB to +16.5 dB

Control step: 0.5 dB

#### Note

The “MAX VOL.” setting takes priority over the initial volume setting.

### 3 SOUND MENU

Use this feature to adjust the audio parameters.

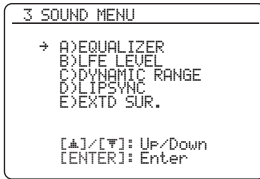

#### Equalizer A)EQUALIZER

Use this feature to select the parametric equalizer or the graphic equalizer.

#### Equalizer type select EQ TYPE SELECT

Use this feature to select the type of equalizer.

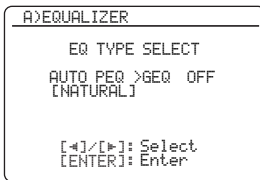

Choice	Functions
AUTO PEQ	Uses the parametric equalizer adjusted in "AUTO SETUP" (see page 32).
GEQ	Adjusts the built-in 7-frequency band graphic equalizer so that the tonal quality of the speakers matches. Press <b>ENTER</b> to display the graphic equalizer screen.
OFF	Deactivates the equalizing feature.



Currently applied parametric equalizer type (see page 32) appears under "AUTO PEQ".

#### Note

You can select "AUTO PEQ" only when you carry out "AUTO SETUP" in advance (see page 31). In this case, "AUTO PEQ" is automatically selected as the default setting.

#### Graphic equalizer GEQ

Use this feature to match the tonal quality of the center, surround L/R and surround back L/R, and surround back speakers with that of the front L/R speakers. You can adjust 7 frequency bands (63 Hz, 160 Hz, 400 Hz, 1 kHz, 2.5 kHz, 6.3 kHz, 16 kHz).

Control range: -6.0 dB to +6.0 dB

Control step: 0.5 dB

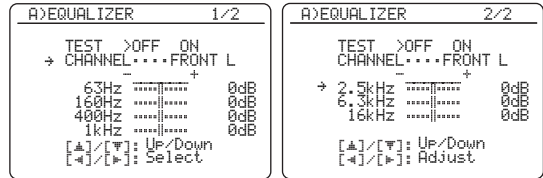

Press **ENTER** / **DOWN** to select a frequency band and **LEFT** / **RIGHT** to adjust the selected frequency band.

#### Note

The "GEQ" parameter can be adjusted only when "GEQ" is selected in "EQ TYPE SELECT".

#### Test tone TEST

Use this feature to make adjustments of "GEQ" while listening to a test tone. To select "TEST", press **ENTER** / **DOWN** repeatedly in the graphic equalizer screen.

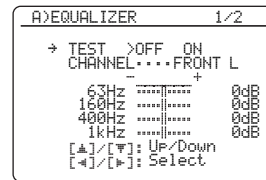

Choice	Functions
OFF	Does not output test tones and output the currently selected source component.
ON	Outputs test tones from the selected speakers.

**Low-frequency effect level**

B>LFE LEVEL

Use this feature to adjust the output level of the LFE (low-frequency effect) channel according to the capacity of your subwoofer or headphones. The LFE channel carries low-frequency special effects which are only added to certain scenes. This setting is effective when the input signal contains the LFE signal.

Control range: -20 to 0 dB

Control step: 1 dB



**Speakers** SPEAKER

Adjusts the speaker LFE level.

**Headphones** HEADPHONE

Adjusts the headphone LFE level.

**Note**

Depending on the settings of “LFE/BASS OUT” (see page 68), some signals may not be output at the SUBWOOFER PRE OUT jack.

**Dynamic range** C>DYNAMIC RANGE

Use this feature to select the amount of dynamic range compression to be applied to your speakers or headphones. This setting is effective only when this unit is decoding bitstream signals.

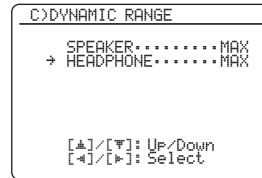

**Speakers** SPEAKER

Adjusts the dynamic range compression for the speakers.

**Headphones** HEADPHONE

Adjusts the dynamic range compression for the headphones.

Choice	Functions
MIN/AUTO	<ul style="list-style-type: none"> <li>MIN: Adjusts the dynamic range to narrow when this unit is decoding bitstream signals (except Dolby TrueHD).</li> <li>AUTO: Adjusts the dynamic range according to the instruction of the input source signals when this unit is decoding Dolby TrueHD signals.</li> </ul>
STD	Adjusts the dynamic range to medium. When this unit is decoding Dolby TrueHD signals, the dynamic range control is always active regardless of the instruction of the input source signals.
MAX	Preserves the greatest amount of dynamic range.

■ **Audio and video synchronization (lip sync)** D>LIPSYNC

Use this feature to adjust the audio and video synchronization.

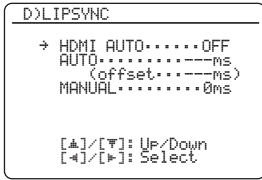

**HDMI automatic lip sync mode** HDMI AUTO

If the connected video monitor is connected to the HDMI OUT jack of this unit and compatible with the automatic audio and video synchronization function (automatic lip sync), this unit adjusts the audio and video synchronization automatically. Use this feature to activate or deactivate the automatic lip sync.

Choices: ON, **OFF**

**If the connected video monitor is compatible with the automatic lip sync:**

Select “ON”. Use “AUTO” to make fine adjustments of the audio and video synchronization.

**If the video monitor is not compatible with the automatic lip sync or you do not want to use the automatic lip sync:**

Select “OFF”. Use “MANUAL” to adjust the audio and video synchronization.

**Auto delay** AUTO

Use this feature to make fine adjustments of the audio and video synchronization when you set “HDMI AUTO” to “ON”.

Control range: **0** to 240 ms

Control step: 1 ms



“offset” indicates the difference between the value of the audio delay that this unit sets automatically and the value of the audio delay that you set in “AUTO”. This unit stores the value of “offset” and applies the value to other automatic lip sync compatible video monitors.

**Manual delay** MANUAL

Use this feature to adjust the delay of the sound output manually to synchronize audio with video images when you set “HDMI AUTO” to “OFF”.

Control range: **0** to 240 ms

Control step: 1 ms

■ **Extended surround** E>EXTD SUR.

Use this feature to enjoy 6.1/7.1-channel playback for multi-channel sources using the Dolby Pro Logic IIX, Dolby Digital EX, or DTS-ES decoders by using the connected surround back speakers.

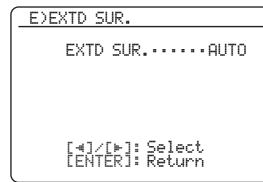

Choice	Functions
<b>AUTO</b>	Activates the optimum decoder to play back signals in 6.1/7.1 channels when this unit recognizes a signal flag being input.
PLIIXMovie	Plays back Dolby Digital or DTS signals in 7.1 channels using the Pro Logic IIX movie decoder.
PLIIXMusic	Plays back Dolby Digital or DTS signals in 6.1/7.1 channels using the Pro Logic IIX music decoder.
EX/ES	Plays back Dolby Digital or DTS signals in 6.1/7.1 channels using the Dolby Digital EX or DTS-ES decoder.
OFF	Does not use any decoders to create 6.1/7.1 channels.

## 4 INPUT MENU

Use this menu to adjust the parameters of each input source.

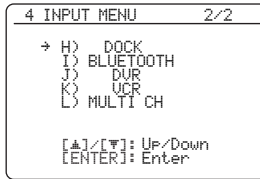
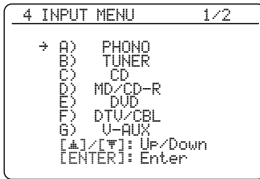

Input source	Parameter
A)PHONO	I/O ASSIGNMENT
B)TUNER	INPUT RENAME
C)CD	VOL. TRIM
D)MD/CD-R	DECODER MODE
E)DVD	
F)DTV/CBL	
G)V-AUX	
J)DVR	
K)VCR	
H)DOCK	INPUT RENAME VOL. TRIM STANDBY CHARGE
I)BLUETOOTH	INPUT RENAME VOL. TRIM START PAIRING
L)MULTI CH	INPUT RENAME VOL. TRIM BGV INPUT CH FRONT

### Note

Some parameters described above may not be available for all input sources and some parameters are only available for specific input sources.

## Input/output assignment

### I/O ASSIGNMENT

Use this feature to assign the input/output jacks according to the component to be used if the initial settings of this unit do not correspond to your needs. Change the parameter to reassign the respective jacks and effectively connect more components.

Once the input/output jacks are reassigned, you can select the corresponding component by using the **INPUT** selector on the front panel (or the input selector buttons **(5)** on the remote control).

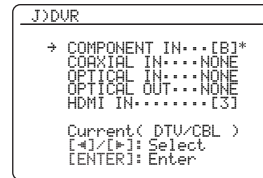

- “NONE” appears in the OSD when any input source is not assigned to the input/output jack.
- Set “OPTICAL OUT” to “(1)” for the digital recording component that you connect to the DIGITAL OUTPUT jack.
- You cannot select a specific item more than once for the same type of jack.
- An asterisk (\*) appears to the right of the input/output jack names that have been changed from their previous settings.
- The currently assigned input source for the selected input/output jack appears in the OSD (“Current( DTV/CBL )” in the display example above).

**Input rename** INPUT RENAME

Use this feature to change the name of the input source that appears in the OSD and in the front panel display.

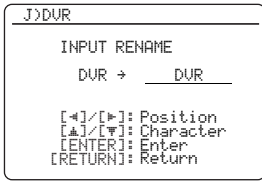

**1** Press **Ⓞ**←/→ to place the “\_” (underscore) under the space or the character you want to edit.

**2** Press **Ⓞ**▲/▼ to select the character you want to use and then press **Ⓞ**←/→ to move to the next space.

**Notes**

- You can use up to 9 characters for each input.
- Press **Ⓞ**▼ to change the character in the following order, or press **Ⓞ**▲ to go in the reverse order:  
 A to Z, 0 to 9, a to z, symbols (#, \*, -, +, etc.), space.

**3** Repeat steps 1 through 2 to rename each input source.

**4** Press **Ⓞ**ENTER to complete.

**Volume trim** VOL. TRIM

Use this feature to adjust the level of the signal input at each jack. This feature is useful if you want to balance the level of each input source to avoid sudden changes in volume when switching between input sources.

Control range: -6.0 dB to +6.0 dB

Control step: 0.5 dB

Initial setting: 0.0 dB

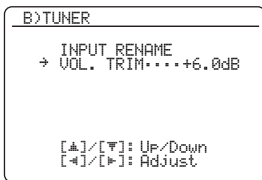

This parameter also affects the signals output at the audio ZONE OUT jacks.

**Decoder mode** DECODER MODE

Use this feature to switch the decoder activation mode. When you select “DTS” and digital audio signals are input, this unit always activates the DTS decoder and only plays back the DTS digital audio signals.

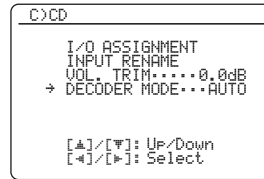

Choice	Functions
AUTO	Automatically detects digital audio signal input types and selects the appropriate decoder.
DTS	Activates the DTS decoder and plays back only DTS digital audio signals when digital audio signals are input.

**Note**

“DECODER MODE” is only available when the digital audio input jacks (HDMI, OPTICAL, and/or COAXIAL) are assigned to the selected input source.

**Charge on standby** STANDBY CHARGE

Use this feature to select whether this unit charges the battery of the stationed iPod or not when this unit is in the standby mode.

Choice	Functions
AUTO	Charges the battery of the stationed iPod when this unit is turned on and in the standby mode.
OFF	Charges the battery of the stationed iPod only when this unit is turned on.

## Start pairing START PAIRING

Use this feature to start pairing the connected Yamaha Bluetooth adapter (such as YBA-10, sold separately) with your Bluetooth component. For details about the pairing, refer to “Pairing the Bluetooth™ adapter and your Bluetooth™ component” on page 54.

To ensure security, a time limit of 8 minutes is set for the pairing operation. You are recommended to read and fully understand all the instructions before starting.

### 1 Press **Ⓜ** **ENTER** to start pairing.

The connected Bluetooth adapter starts searching Bluetooth components. “Searching...” appears in the video monitor.

### 2 Check that the Bluetooth component detects the Bluetooth adapter.

If the Bluetooth component the Bluetooth adapter, “YBA-10 YAMAHA” (example) appears in the Bluetooth device list.

### 3 Select the Bluetooth adapter in the Bluetooth device list and then enter the pass key “0000” on the Bluetooth component.

Once this unit completes the pairing successfully, “Pairing completed” appears.



To cancel the pairing, press **Ⓜ** **RETURN** to exit from “START PAIRING”.

### 4 Press **Ⓜ** **RETURN** to exit from “START PAIRING”.

#### Notes

- If the connected Bluetooth adapter cannot find any Bluetooth components, “Not found” appears.
- If a Bluetooth adapter is not connected to this unit, “No Bluetooth Adapter” appears.

## Multi-channel input BGV BGV

Use this feature to select the video source played in the background of the sources input at the MULTI CH INPUT jacks.

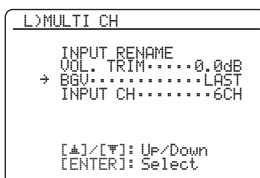

Choice	Functions
<b>LAST</b>	Automatically selects the last selected video source as the background video source.
DVD, DTV/ CBL, DVR, VCR, V-AUX	Selects the corresponding input source as the background video source.
OFF	Does not play the video source in the background.

## Input channels INPUT CH

Use this setting to select the number of channels input from an external decoder (see page 25).

Choices: **6CH**, **8CH**

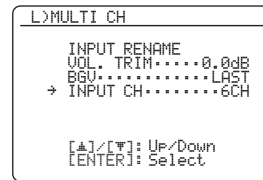

If the connected component outputs discrete 6-channel audio signals.

Select “6CH”.

If the connected component outputs discrete 8-channel audio signals.

Select “8CH”. Also set “FRONT” (see below) to the analog audio jacks at which the front left and right channel signals output from the connected component are input.

## Front left and right channels input jack FRONT

If you selected “8CH” in “INPUT CH”, you can select the analog audio jacks at which the front left and right channel signals output from the connected external decoder is input.

Choices: CD, MD/CD-R, **DVD**, DTV/CBL, DVR, VCR, V-AUX

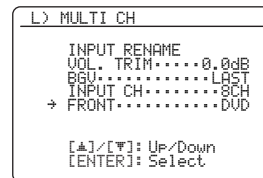

#### Note

“FRONT” parameter appears only when you set “INPUT CH” to “8CH”.



## 5 OPTION MENU

Use this menu to adjust the optional system parameters.

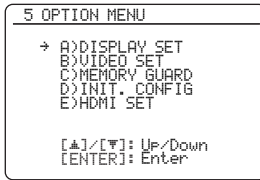

### ■ Display settings A) DISPLAY SET

#### Note

Use “VIDEO” of “INIT” in “ADVANCED SETUP” to set “OSD SHIFT” to the factory presets (see page 96).

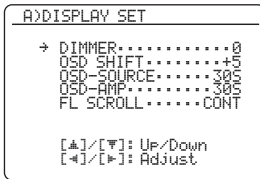

#### Dimmer DIMMER

Use this feature to adjust the brightness of the front panel display.

Control range: -4 to 0

Control step: 1

- Press **Ⓢ**◀ to make the front panel display dimmer.
- Press **Ⓢ**▶ to make the front panel display brighter.

#### OSD shift OSD SHIFT

Use this feature to adjust the vertical position of the OSD.

Control range: -5 (downward) to +5 (upward)

Control step: 1

Initial setting: 0

- Press **Ⓢ**◀ to lower the position of the OSD.
- Press **Ⓢ**▶ to raise the position of the OSD.

#### Source feature OSD display time OSD-SOURCE

Use this feature to set the amount of time to display the iPod menu in the OSD after you perform a certain operation.

Choice	Functions
ON	Displays the OSD unceasingly during an operation.
10S	Turns off the OSD 10 seconds after you perform a certain operation.
30S	Turns off the OSD 30 seconds after you perform a certain operation.

#### Amplifier function OSD display time OSD-AMP

Use this feature to set the amount of time to display the status information screen after you perform a certain operation.

Choice	Functions
ON	Displays the OSD unceasingly during an operation.
10S	Turns off the OSD 10 seconds after you perform a certain operation.
30S	Turns off the OSD 30 seconds after you perform a certain operation.

#### Front panel display scroll FL SCROLL

Use this feature to set the mode to display the iPod menu (such as song title or channel name) in the front panel display.

Choice	Functions
CONT	Continuous mode. Select this to display the operation status in the front panel display in a continuous manner.
ONCE	Scroll-once mode. Select this to display the operation status in the front panel display by the first 14 alphanumeric characters after scrolling all characters once.

**Video settings** B)VIDEO SET

**Note**

Use “VIDEO” of “INIT” in “ADVANCED SETUP” to set the parameters in “VIDEO SET” to the factory presets (see page 96).

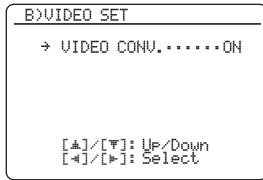

**Video conversion** VIDEO CONV.

Use this feature to set whether to convert the video signals input at the VIDEO, S VIDEO, and COMPONENT VIDEO jacks.

Choice	Functions
ON	Converts composite, S-video, and component video signals interchangeably and up-converts composite, S-video, and component video signals to HDMI video signals.
OFF	Does not convert any signals.

**Notes**

- This unit does not convert 480 line video signals and 576 line video signals interchangeably.
- The analog component video signals with 480i (NTSC)/576i (PAL) of resolution are converted into the S-video or composite video signals and output at the S VIDEO MONITOR OUT and VIDEO MONITOR OUT jacks.
- The converted video signals are only output at the MONITOR OUT jacks. When recording a video source, you must make the same type of video connections between each component.
- When composite video or S-video signals from a VCR are converted into component video signals, the picture quality may suffer depending on your VCR.
- Unconventional signals input at the composite video or S-video jacks cannot be converted or may be output abnormally. In such cases, set “VIDEO CONV.” to “OFF”.

**Memory guard** C)MEMORY GUARD

Use this feature to prevent accidental changes to sound field program parameter and other system settings.

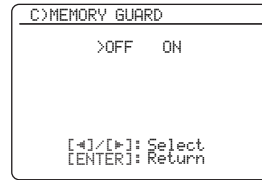

Choice	Functions
OFF	Turns off the “MEMORY GUARD” feature.
ON	Protects: <ul style="list-style-type: none"> <li>– sound field program parameters</li> <li>– “AUTO SETUP” items</li> <li>– all speaker levels</li> <li>– “MANUAL SETUP” items</li> </ul>

**Notes**

- You can change the following parameters even if “MEMORY GUARD” is set to “ON”:
  - “EXTD SUR.” in “SOUND MENU” (see page 75)
  - “DECODER MODE” in “INPUT MENU” (see page 77)
  - “MEMORY GUARD”
- When “MEMORY GUARD” is set to “ON”, “” appears at the top right of the “SET MENU” screen.
- You can change the settings of “SUR.” in the sound field program parameter screen (see page 61) even if “MEMORY GUARD” is set to “ON”.

**Initial configuration** D>INIT. CONFIG

Use this feature to select the settings of the audio input jack select, active decoders and extended surround when you turn on this unit.

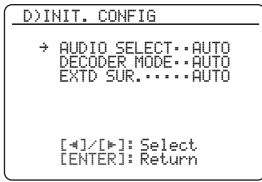

**Audio select** AUDIO SELECT

Use this feature to designate the default audio input jack select setting (see page 43) for the input sources connected to the DIGITAL INPUT jacks when you turn on the power of this unit.

Choice	Functions
<b>AUTO</b>	Automatically detects the type of input signals and selects the appropriate audio input jack select setting.
LAST	Automatically selects the last input jack select setting used for the connected input source.

**Decoder mode** DECODER MODE

Use this feature to designate the default decoder mode (see page 77) for the input sources connected to the DIGITAL INPUT jacks when you turn on the power of this unit.

Choice	Functions
<b>AUTO</b>	Automatically detects the type of input signals and select the appropriate decoder mode setting.
LAST	Automatically selects the last decoder mode setting used for the connected input source.

**Extended surround** EXT. SUR.

Use this feature to designate the extended decoder mode (see page 75) for the input sources connected to the DIGITAL INPUT jacks when you turn on the power of this unit.

Choice	Functions
<b>AUTO</b>	Automatically detects the digital audio input signals and activates the appropriate decoder.
LAST	Automatically selects the last decoder mode set for “EXTD SUR.” in “SOUND MENU”.

**HDMI set** E>HDMI SET

Use this feature to select the component to play back HDMI audio signals.

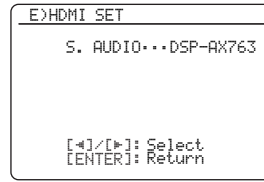

**Support audio** S. AUDIO

Use this feature to select whether to play back HDMI audio signals on this unit or on another HDMI component connected to the HDMI OUT jack on the rear panel of this unit.

Choice	Functions
<b>DSP-AX763</b>	Plays back HDMI audio signals on this unit. The HDMI audio signals input at the HDMI input jacks of this unit are not output to the HDMI component connected to the HDMI OUT jack on the rear panel of this unit.
OTHER	Plays back HDMI audio signals on another HDMI component connected to the HDMI OUT jack.

**Notes**

- This unit transmits audio and video signals input at the HDMI input jacks to the HDMI out jack only when this unit is turned on even if “S.AUDIO” is set to “OTHER”.
- Available audio/video signals depend on the specification of the connected video monitor. Refer to the instruction manual of each connected component.

# Remote control features

In addition to controlling this unit, the remote control can also operate other audiovisual components made by Yamaha and other manufacturers. To control your TV or other components, you must set up the appropriate remote control code for each input source (see page 84).

## Controlling this unit, a TV, or other components

### ■ Controlling this unit

Set the operation mode selector to **16 AMP** to control this unit.

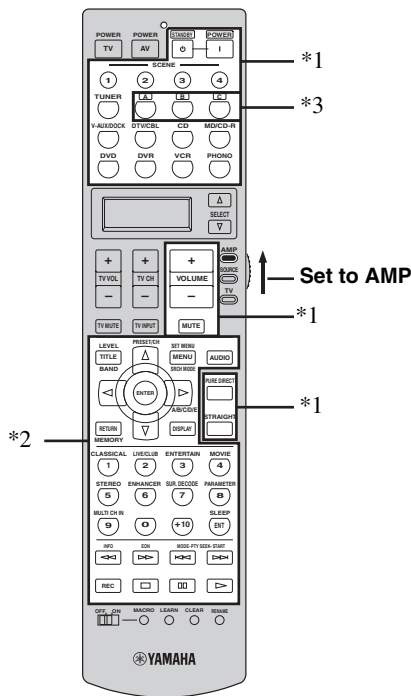

### ■ Controlling a TV

Set the operation mode selector to **16 TV** to control your TV. To control your TV, you must set the appropriate remote control code for **5 DTV/CBL** or **5 PHONO** (see page 84). When you set the remote control codes for both **5 DTV/CBL** and **5 PHONO**, priority is given to the one set for **5 DTV/CBL**.

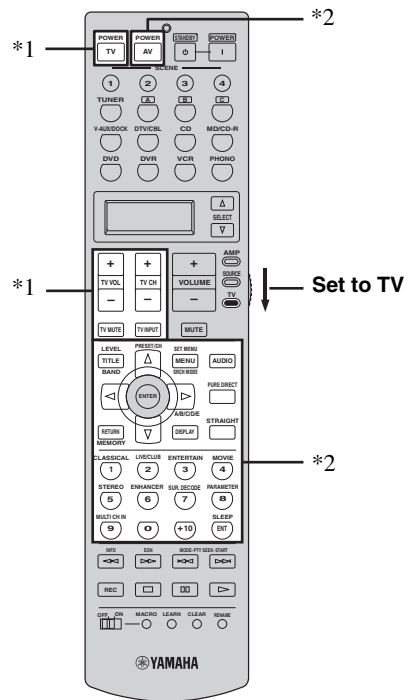

### Notes

- \*1 These buttons always control this unit regardless of the operation mode selector position.
- \*2 These buttons control this unit only when the component operation mode selector is set to **16 AMP**.
- \*3 **5 A, B, or C**, is the optional component control area button. You can control the desired component without changing the input source of this unit.

### Notes

- \*1 These buttons always control your TV regardless of the operation mode selector position.

Remote control	Digital TV/Cable TV
TV POWER	Turns on or off the power.
TV VOL +/-	Increases or decreases the volume level.
TV CH +/-	Changes the channel number.
TV MUTE	Mutes the audio output.
TV INPUT	Changes the input source.

- \*2 These buttons control your TV only when the operation mode selector is set to **16 TV**. For details, see the "TV" column on page 83.

### ■ Controlling other components

Set the operation mode selector to **⑩SOURCE** to control other components selected with the input selector buttons (⑤). You must set the appropriate remote control code for each input source in advance (see page 84). The following table shows the function of each control button used to control other components assigned to each input selector button (⑤). Be advised that some buttons may not correctly operate the selected component.



The remote control has 12 modes (control areas) to control components so that the remote control can operate up to 12 different components.

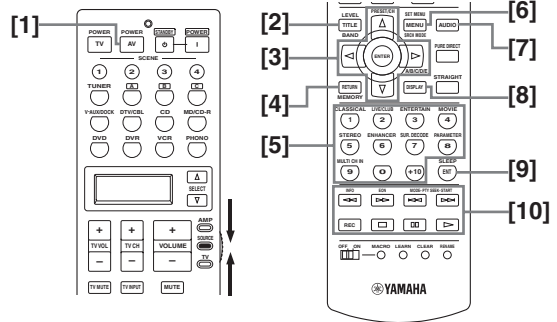

	DVD player/ DVD recorder	VCR	Cable TV/ Satellite tuner	TV	LD player	CD player	MD recorder/ CD recorder	Tape deck	Tuner
[1] AV POWER	Power *1	Power *1	Power *1	VCR power *2	Power *1	Power *1	Power *1	Power *1	Power *1
[2] TITLE	Title	Title	Title	Title					Band
[3] ENTER	Menu enter		Menu select	Menu select					
PRESET/CH Δ	Menu up		Menu up	Menu up					Preset up (1 to 8)
PRESET/CH ∇	Menu down		Menu down	Menu down					Preset down (1 to 8)
A/B/C/D/E ◀	Menu left		Menu left	Menu left					Preset down (A to E)
A/B/C/D/E ▶	Menu right		Menu right	Menu right				Direction A/B	Preset up (A to E)
[4] RETURN	Return	Return	Return	Return					Memory
[5] 1-9, 0, +10	Numeric buttons	Numeric buttons	Numeric buttons	Numeric buttons	Numeric buttons	Numeric buttons	Numeric buttons		Preset stations (1 to 8) / Numeric buttons
[6] MENU	Menu		Menu	Menu					Search mode
[7] AUDIO	Audio				Audio				
[8] DISPLAY	Display		Display	Display	Display	Display	Display		
[9] ENT		Enter	Enter/recall	Enter					Enter
[10] ◀◀	Search backward	Search backward	DVR search backward *2	DVR search backward *2	Search backward	Search backward	Search backward	Search backward	Information
▶▶	Search forward	Search forward	DVR search forward *2	DVR search forward *2	Search forward	Search forward	Search forward	Search forward	EON
◀◀	Skip backward		DVR skip backward *2	DVR skip backward *2	Chapter/Skip backward	Skip backward	Skip backward	Direction back	Program type seek mode
▶▶	Skip forward		DVR skip forward *2	DVR skip forward *2	Chapter/Skip forward	Skip forward	Skip forward	Direction forward	Program type seek mode
REC	Disc skip (player) Rec (recorder)	Rec	DVR rec *2	DVR rec *2		Disc skip	Rec	Rec	
□	Stop	Stop	DVR stop *2	DVR stop *2	Stop	Stop	Stop	Stop	
⏸	Pause	Pause	DVR pause *2	DVR pause *2	Pause	Pause	Pause	Pause	
▶	Play	Play	DVR play *2	DVR play *2	Play	Play	Play	Play	

#### Notes

\*1 This button is operational only when the original remote control supplied with the component has a POWER button.

\*2 These buttons operate your VCR or DVR when you set the appropriate remote control code for DVR (see page 84).

### ■ Selecting a component to be controlled

You can select a component to be controlled independently of the input source selected with the input selector buttons.

Press **⑥** **SELECT**  $\Delta$  /  $\nabla$  repeatedly to select the desired component.

The name of the component to be controlled appears in the display window (⑥) on the remote control.



### ■ Controlling optional components (Option mode)

“OPTN” is an optional component control area that can be programmed with remote control functions independently from any input source. This area is useful for programming commands that are to be used only as a part of a macro function or for components that do not have a valid remote control code.

To select the option mode, press **⑥** **SELECT**  $\Delta$  /  $\nabla$  repeatedly until “OPTN” appears in the display window (⑥) on the remote control.



**Note**

You cannot set a remote control code for the optional area. See page 86 to program buttons operated within this component control area.

## Setting remote control codes

You can control other components by setting the appropriate remote control codes. Codes can be set up for each control area. For a complete list of available remote control codes, refer to “List of remote control codes” at the end of this manual.

The following table shows the default component (Library: component category) and the remote control code for each control area.

### Remote control code default settings

Control area	Component category	Manufacturer	Default code
TUNER	TUNER	Yamaha	2602
A	TAPE	Yamaha	2700
B	LD	Yamaha	2200
C	TUNER	Yamaha	2607
V-AUX/DOCK	TUNER	Yamaha	2606
DTV/CBL	TV	-	-
CD	CD	Yamaha	2300
MD/CD-R	CD-R	Yamaha	2400
DVD	DVD	Yamaha	2100
DVR	DVR	Yamaha	2807
VCR	VCR	-	-
PHONO	TV	-	-

**Note**

You may not be able to operate your Yamaha component even if a Yamaha remote control code is preset as listed above. In this case, try setting another Yamaha remote control code.

- 1 Set the operation mode selector to **⑩** **SOURCE** and then press an input selector button (⑤) to select the control area you want to set up.

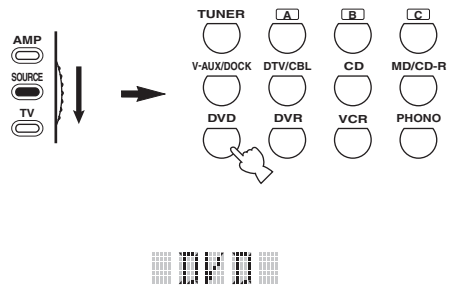

## 2 Press and hold **LEARN** for about 3 seconds using a ballpoint pen or similar object.

The library name (e.g. L;DVD) and the name of the selected control area (e.g. DVD) appear alternately in the display window (⑥) on the remote control.

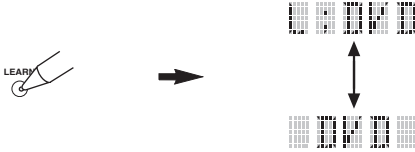

- You can set a remote control code of a different type of component to an control area. Press **ENTER** repeatedly to change the library (component category).  
Library choices: L;DVD, L;DVR, L;LD, L;CD, L;CDR, L;MD, L;TAP (tape), L;TUN (tuner), L;AMP, L;TV, L;CAB (cable), L;SAT (satellite), L;VCR
- If you want to setup for another control area, press the input selector button, or press **SELECT**  $\Delta$  /  $\nabla$  repeatedly to select the control area.

### Notes

- Be sure to press and hold **LEARN** for at least 3 seconds, otherwise the learning process will start.
- If you do not complete each of the following steps within 30 seconds, the setting mode will be automatically canceled. In this case, start over from step 2.

## 3 Press **ENTER**.

The four-digit code set for the selected component appears in the display window (⑥).

### Note

“0000” appears in the display window (⑥) if no code has been set.

## 4 Press the numeric buttons (⑪) to enter the four-digit remote control code for the component you want to use.

For a complete list of available remote control codes, refer to “List of remote control codes” at the end of this manual.

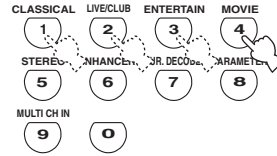

## 5 Press **ENTER** to set the number.

“OK” appears in the display window (⑥) on the remote control if setting was successful.

“NG” appears in the display window (⑥) on the remote control if the setting was unsuccessful. In this case, start over from step 3.



If you continuously want to set up another code for another component, press the input selector button (⑤), or **SELECT**  $\Delta$  /  $\nabla$  repeatedly to select the component, then repeat steps 2 through 5.

## 6 Press **LEARN** again to exit from the setup mode.



## 7 Press **ENTER** or **AV POWER** to confirm whether you can control your component using the remote control.

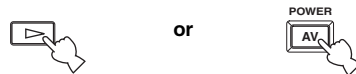

If operation is not possible and the manufacturer of your component has more than one code, try each of them until you find the correct one.

### Notes

- “ERROR” appears in the display window (⑥) on the remote control if you press a button not indicated in the respective step, or when you press more than one button simultaneously.
- The supplied remote control does not contain all possible codes for commercially available audio and video components (including Yamaha components). If operation is not possible with any of the remote control codes, program the new remote control function using the learn feature (see “Programming codes from other remote controls” on page 86) or use the remote control supplied with the component.
- Functions programmed using the learn feature take priority over remote control code functions.

## Programming codes from other remote controls

You can program remote control codes from other remote controls. Use the learn feature if you want to program functions not included in the basic operations covered by the remote control codes, or an appropriate remote control code is not available. You can program the function of other remote control to the buttons in the highlighted areas in the following illustration. The buttons can be programmed independently for each control area.

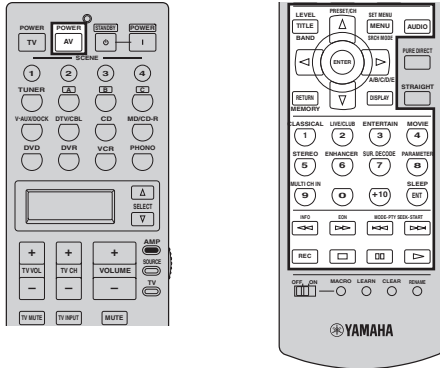

### Note

The remote control transmits infrared rays. If the other remote control also uses infrared rays, this remote control can learn most of its functions. However, you may not be able to program some special signals or extremely long transmissions. Refer to the operating instructions for the other remote control.

- 1 Set the operation mode selector to **⑬SOURCE** and then press an input selector button **⑤** to select a control area.

### Note

Make sure that the operation mode selector is set to **⑬SOURCE**. When you set the operation mode selector to **⑬AMP** and program a remote control codes from other remote controls, the programmed key cannot operate the amplifier function of this unit.

- 2 Place this remote control about 5 to 10 cm (2 to 4 in) apart from the other remote control on a flat surface so that their infrared transmitters are aimed at each other.

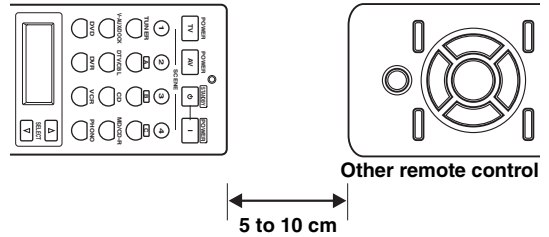

- 3 Press **⑬LEARN** using a ballpoint pen or similar object.

“LEARN” and the name of the selected control area (e.g. “DVD”) appear alternately in the display window **⑥** on the remote control.

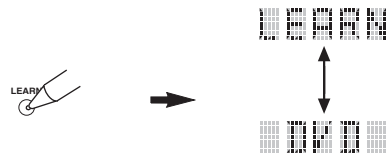

### Notes

- Do not press and hold **⑬LEARN**. If you hold it down for more than 3 seconds, the remote enters the remote control code setting mode.
- If you do not complete each of the following steps within 30 seconds, the learning mode will be automatically canceled. In this case, start over from step 3.

- 4 Press the button for which you want to program the new function.

“LEARN” appears in the display window **⑥** on the remote control.





## 5 Press and hold the button you want to program on the other remote control until “OK” appears in the display window (Ⓢ) on the remote control.

“NG” appears in the display window (Ⓢ) on the remote control if learning was unsuccessful. In this case, start over from step 4.

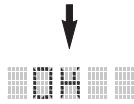
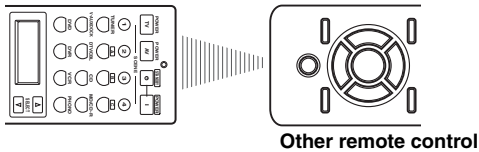

- If you want to program another function, repeat steps 4 and 5.
- If you continuously want to program another function for another component, press ⓈSELECT  $\Delta$  /  $\nabla$  to select the component, and then repeat steps 4 and 5.

## 6 Press ⓈLEARN again to exit the learning mode.



### Notes

- “ERROR” appears in the display window (Ⓢ) on the remote control if you press a button not indicated in the respective step, or when you press more than one button simultaneously.
- This remote control can learn approximately 200 functions. However, depending on the signals learned, “FULL” may appear in the display before you program 200 functions. In this case, clear unnecessary programmed functions to make room for further learning.
- Learning may not be possible in the following cases:
  - when the batteries in the remote control for this unit or other components are weak.
  - when the distance between the two remote controls is too great or too small.
  - when the remote control infrared windows are not facing each other at the appropriate angle.
  - when the remote control is exposed to direct sunlight.
  - when the function to be programmed is continuous or uncommon.

## Changing source names in the display window

You can change the name of the input source that appears in the display window (Ⓢ) on the remote control if you want to use a different name than the factory preset. This feature is useful when you have set a control area to control a different component.

### 1 Set the operation mode selector to ⓈAMP or ⓈSOURCE and then press an input selector button (Ⓢ) to select the control area you want to rename.

The name of the selected control area appears in the display window (Ⓢ).

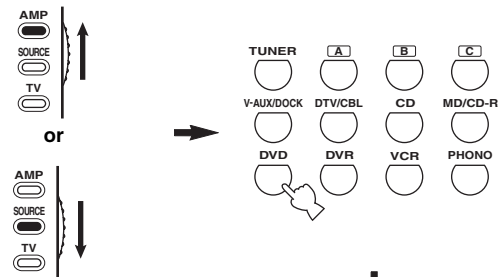

### 2 Press ⓈRENAME using a ballpoint pen or similar object.



### Note

If you do not complete each of the following steps within 30 seconds, the renaming mode will be automatically canceled. In this case, start over from step 2.

**3 Press  $\text{Ⓔ}$  /  $\text{Ⓕ}$  /  $\text{Ⓖ}$  to select and enter a character.**

Pressing  $\text{Ⓔ}$  /  $\text{Ⓕ}$  changes the character as follows:

A to Z, 1 to 9, 0, + (plus), - (hyphen), ; (semicolon), / (slash), and space.

Pressing  $\text{Ⓔ}$  /  $\text{Ⓕ}$  changes the characters in reverse order.

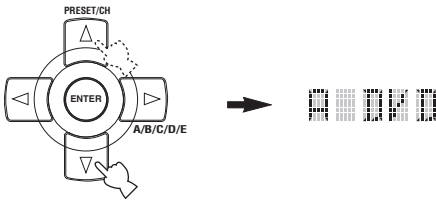

**4 Press  $\text{Ⓔ}$  /  $\text{Ⓗ}$  to move the cursor to the next position.**

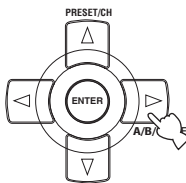

Press  $\text{Ⓔ}$  /  $\text{Ⓖ}$  to move the cursor to the previous position.

**5 Press  $\text{Ⓔ}$  ENTER to set the new name.**

“OK” appears in the display window (Ⓔ) on the remote control if renaming was successful.

“NG” appears in the display window (Ⓔ) on the remote control if renaming was unsuccessful. In this case, start over from step 3.



If you continuously want to rename another control area, press the input selector button (Ⓔ), or press  $\text{Ⓔ}$  SELECT  $\text{Ⓕ}$  /  $\text{Ⓖ}$  repeatedly to select the component, then repeat steps 3 through 5.

**6 Press  $\text{Ⓔ}$  RENAME again to exit the renaming mode.**



**Note**

“ERROR” appears in the display window (Ⓔ) on the remote control if you press a button not indicated in the respective step, or when you press more than one button simultaneously.

**Macro programming features**

The macro programming feature makes it possible to perform a series of operations with the press of a single button. For example, when you want to play a CD, normally you would turn on the components, select the CD input, and press the play button to start playback. The macro programming feature lets you perform all of these operations simply by pressing the CD macro button. The buttons listed as macro buttons below are factory set with macro programs. You can also program your own macros (see page 90).

**MACRO operations**

**Macro buttons**

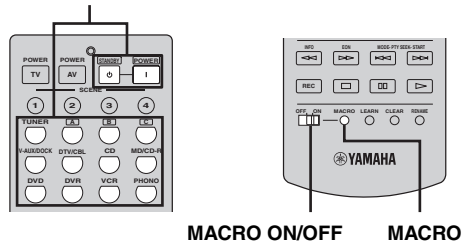

**1 Set the  $\text{Ⓔ}$  MACRO ON/OFF selector to ON.**

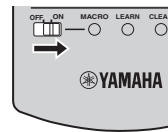

**2 Press the desired macro button.**

**3 Set the  $\text{Ⓔ}$  MACRO ON/OFF selector to OFF when you finish to using the macro programming operation.**

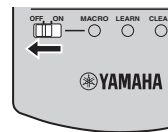

**Notes**

- While the remote control is running a macro program, it does not accept any other operation until it has completed running the program (the transmission indicator stops flashing).
- Continue to aim the remote control at the component the macro is operating until the macro operation is complete.

## ■ Default macro functions

Pressing macro button	To automatically transmit these signals in order		
	First	Second	Third
		—	—
	(*1)	(*2)	—
	(*1)		—
			—
			—
			—
			—
			—
			(CD area) (*3)
			(MD/CD-R area) (*3)
			(DVD area) (*3)
			(DVR area) (*3)
			(VCR area) (*3)
			—

\*1 You can turn on some components (including Yamaha components) connected to this unit by connecting them to the AC OUTLETS on the rear panel of this unit. Power control may not be synchronized with this unit depending on the component.

For details, refer to the operating instructions for the connected component.

\*2 When the remote control code for your TV is set up for either **⑤DTV/CBL** or **⑥PHONO** (see page 84), you can turn on the power of your TV without selecting an input source. The remote control code set up for **⑤DTV/CBL** takes priority over the one for **⑥PHONO**.

\*3 Playback can be started for any Yamaha remote control-compatible CD player, CD recorder, DVD player, or DVD recorder. When using macros to operate other components, you will need to program the play button on the control area of that component (see page 86) or set a remote control code (see page 84).

## ■ Programming macro operations

You can program your own macro and use the macro programming feature to transmit several remote control commands in sequence at the press of a button. Be sure to set up remote control codes or perform learning operations before programming the macro.

### Notes

- The default macro is not cleared when a new macro is programmed for a button. The default macro can be used again when the programmed macro is cleared.
- It is not possible to add a new signal (macro step) to the default macro. Programming a macro changes all macro contents.
- We do not recommend programming continuous operations such as volume control in a macro.

### 1 Set the operation mode selector to ⑩AMP or ⑩SOURCE and then press ⑬MACRO using a ballpoint pen or similar object.

“MCR ?” appears in the display window (⑥) on the remote control.

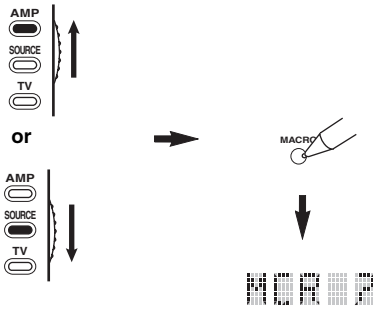

### Note

If you do not complete each of the following steps within 30 seconds, the macro programming mode will be automatically canceled. In this case, start over from step 1.

### 2 Press the macro button you want to use to operate the macro.

The macro button name (e.g. “M;DVD”) and the selected component name (e.g. “DVD”) appear alternately in the display window (⑥) on the remote control.

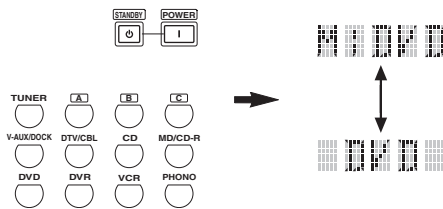

### Note

“AGAIN” appears in the display window (⑥) if you press a button other than a macro button.

### 3 Press the buttons for the functions you want to include in the macro operation in sequence.

You can set up to 10 steps (10 functions). After you have set 10 steps, “FULL” appears and the remote control automatically exits the macro mode. The following example is for programming the following procedure:

Step 1 (“MCR 1”): Press POWER.

Step 2 (“MCR 2”): Press DVD.

Step 3 (“MCR 3”): Press AUDIO.

#### MCR 1: POWER

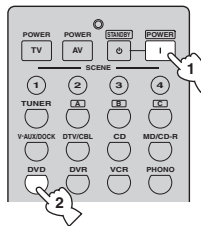

#### MCR 2: DVD

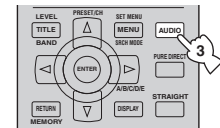
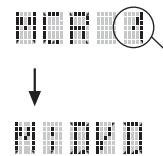

#### MCR 3: AUDIO

### Note

To change the selected control area, press ⑥SELECT Δ / ▽. Pressing the input selector buttons will program a macro step, whereas ⑥SELECT Δ / ▽ only changes the selected control area.

### 4 Press ⑬MACRO again using a ballpoint pen or similar object when the operation sequence you want to program is complete.

### Note

“ERROR” appears in the display window (⑥) if you press more than one button simultaneously.

## Clearing configurations

You can clear all changes made in each function set, such as learned functions, macros, renamed control area names and setup remote control ID.

### ■ Clearing function sets

#### 1 Set the operation mode selector to **AMP** or **SOURCE** and then press **CLEAR** by using a ballpoint pen or similar object.

“CLEAR” appears in the display window (⑥).

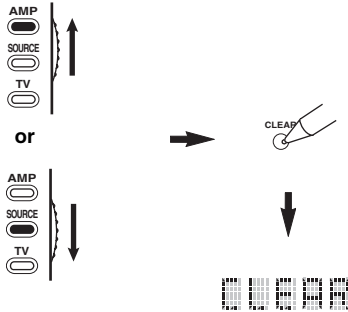

#### Note

If you do not complete each of the following steps within 30 seconds, the clearing mode will be automatically canceled. In this case, start over from step 1.

#### 2 Press **⊙** / **△** / **▽** to select the clear mode.

L;CD (etc.) (L; Name of an control area)	Clears all learned functions in the respective control area. The name of a component is shown after a semicolon (;). Press an input selector button to select the control area.
L;AMP	Clears all learned functions for controlling the amplifier functions of this unit.
L;ALL	Clears all learned functions.
M;ALL	Clears all programmed macros.
RNAME	Clears all renamed source names.
FCTRY	Clears all remote functions and returns the remote to the factory settings.

#### 3 Press and hold **⊙** **CLEAR** again for about 3 seconds.

“WAIT” appears in the display window (⑥). If clearing was successful, “C;OK” appears in the display window (⑥) on the remote control.

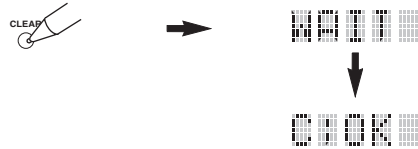

Once you have cleared a learned function for a button, the button reverts to the factory setting (or to the manufacturer setting, if you have set remote control codes).

#### Notes

- “L;ALL” and “FCTRY” may take about 30 seconds to complete.
- “C;NG” appears in the display window (⑥) if clearing was unsuccessful. In this case start over from step 2.
- “ERROR” appears in the display window (⑥) if you press a button not indicated in the respective step, or if you press more than one button simultaneously.

## ■ Clearing a learned function

You can clear the function learned for a certain button in each control area.

- 1 Set the operation mode selector to **AMP** or **SOURCE** and then press an input selector button to select the control area containing the function you want to clear.

The selected component name appears in the display window.

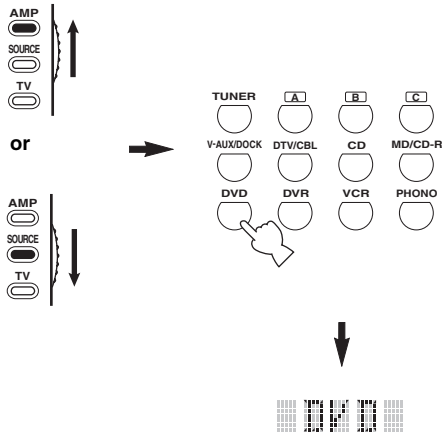

- 2 Press **LEARN** using a ballpoint pen or similar object.

“LEARN” and the selected component name (e.g. “DVD”) appear alternately in the display window.

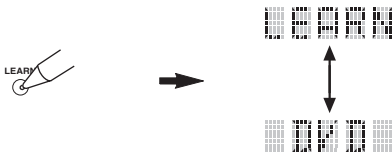

### Notes

- Do not press and hold **LEARN**. If you hold it down for more than 3 seconds, the remote control enters the remote control code setting mode.
- If you do not complete each of the following steps within 30 seconds, the learning mode will be automatically canceled. In this case, start over from step 2.

- 3 Press and hold **CLEAR** using a ballpoint pen or similar object and then press the button you want to clear for about 3 seconds.

“C;OK” appears in the display window if clearing was successful. Once “C;OK” appears in the display window on the remote control, release the ballpoint pen or similar object used to press **CLEAR** to exit the clearing mode. The remote control returns to the learning mode.

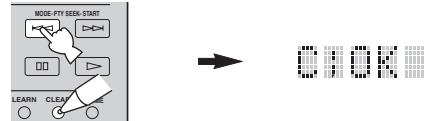

- If you continuously want to clear another function, repeat step 3.
- If you continuously want to clear another function for another component, press **SELECT**  $\Delta$  /  $\nabla$  to select the control area, then repeat step 3.
- Once you clear a learned function, the button reverts to the factory setting (or to the manufacturer setting if you have set remote control codes).

- 4 Press **LEARN** again to exit.

### Notes

- “C;NG” appears in the display window on the remote control if clearing was unsuccessful. In this case, start over from step 2.
- “ERROR” appears in the display window on the remote control if you press more than one button simultaneously.

## ■ Clearing a macro function

You can clear the function programmed for a certain macro button.

- 1 Set the operation mode selector to **AMP** or **SOURCE** and then press **MACRO** using a ballpoint pen or similar object.

“MCR ?” appears in the display window (6) on the remote control.

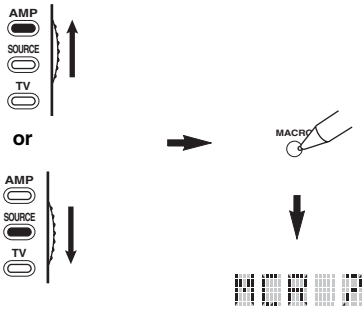

### Note

If you do not complete each of the following steps within 30 seconds, the macro programming mode will be automatically canceled. In this case, start over from step 1.

- 2 Press and hold **CLEAR** using a ballpoint pen or similar object, then press the macro button you want to clear for about 3 seconds. “C;OK” appears in the display window (6) on the remote control if clearing was successful.

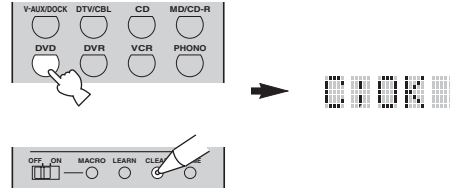

- If you continuously want to clear another function, repeat step 2.
- Once you clear a programmed function, the button reverts to the factory setting (or to the manufacturer setting if you have set remote control codes).

- 3 Press **MACRO** again to exit the macro programming mode.

### Notes

- “C;NG” appears in the display window (6) on the remote control if clearing was unsuccessful. In this case, start over from step 2.
- “ERROR” appears in the display window (6) on the remote control if you press more than one button simultaneously.

# Advanced setup

This unit has additional menus that are displayed in the front panel display. The advanced setup menu offers additional operations to adjust and customize the way this unit operates. Change the initial settings (indicated in bold under each parameter) to reflect the needs of your listening environment.

## Notes

- The settings you make are reflected next time you press **ⓄSTANDBY/ON** to turn on this unit (see page 28).
- Only **ⓄSTANDBY/ON**, **ⓄTONE CONTROL** and the **ⓄPROGRAM** selector are effective while you are using the advanced setup menu.
- No other operations can be made while you are using the advanced setup menu.
- The advanced setup menu is only available in the front panel display.

## Using the advanced setup

**1 Press **ⓄSTANDBY/ON** on the front panel to set this unit to the standby mode.**

**2 Press and hold **ⓄTONE CONTROL** and then press **ⓄSTANDBY/ON** to turn on this unit.**

This unit turns on, and the advanced setup menu appears in the front panel display.



**3 Rotate the **ⓄPROGRAM** selector to select the parameter you want to adjust.**

The name of the selected parameter appears in the front panel display.

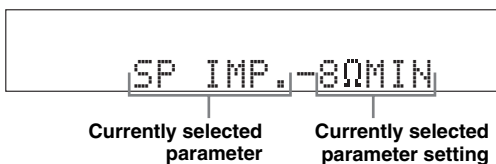

**4 Press **ⓄTONE CONTROL** repeatedly to change the selected parameter setting.**

**5 Press **ⓄSTANDBY/ON** to save the new setting and set this unit to the standby mode.**



The settings you made are reflected next time you turn on this unit.

## ■ Speaker impedance SP IMP.

Use this feature to set the speaker impedance of this unit so that it matches that of your speakers.

Choices: **8ΩMIN**, **6ΩMIN**

- Select “8ΩMIN” to set the speaker impedance to 8 Ω.
- Select “6ΩMIN” to set the speaker impedance to 6 Ω.

SP IMP.	Speaker	Impedance level
8ΩMIN	Front	If you use one set (A or B), the impedance of each speaker must be 8 Ω or higher.
	Center	
	Surround	The impedance of each speaker must be 8 Ω or higher.
	Surround back	
6ΩMIN	Front	If you use one set (A or B), the impedance of each speaker must be 4 Ω or higher.
	Center	
	Surround	The impedance of each speaker must be 6 Ω or higher.
	Surround back	



See page 94 for the operation of the advanced setup.

## Remote control AMP ID REMOTE AMP

Use this feature to set the AMP ID of this unit for remote control recognition. This feature is useful when you operate this unit and the other Yamaha receivers/amplifiers in the same room separately.

Choices: ID1, ID2

- Select “ID1” when the remote control AMP ID code is set to “2201”.
- Select “ID2” when the remote control AMP ID code is set to “2202”.

### Setting remote control AMP ID codes

You need to set the remote control AMP ID code for the remote control.

#### 1 Set the operation mode selector to **AMP** or **SOURCE**.

#### 2 Press and hold **LEARN** for about 3 seconds using a ballpoint pen or similar object and then press **ENTER** repeatedly until “L;AMP” appears in the display window **(6)** on the remote control.

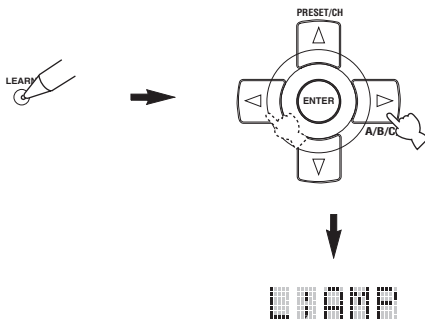

#### Notes

- Be sure to press and hold **LEARN** for at least 3 seconds, otherwise the learning process will start.
- If you do not complete each of the following steps within 30 seconds, the setting mode will be automatically canceled. In this case, start over from step 1.

#### 3 Press **ENTER**.

The four-digit code set for the selected input area appears in the display window **(6)** on the remote control.

#### 4 Press the numeric buttons **(11)** to enter the four-digit remote control code for the input area you want to use.

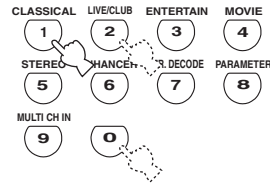

### Remote control AMP ID codes

Select one of the following codes to set the remote control AMP ID code for the input area you want to use.

AMP ID code (remote control setting)	Function	Remote control AMP ID
2201 (initial setting)	To operate this unit using the default code.	ID1 (initial setting)
2202	To operate this unit using an alternative code.	ID2

#### 5 Press **ENTER** to set the number.

“OK” appears in the display window **(6)** if setting was successful.

“NG” appears in the display window **(6)** if the setting was unsuccessful. In this case, start over from step 1.

#### 6 Press **LEARN** again to exit from the setup mode.



See page 94 for the operation of the advanced setup.

### ■ Bi-amplifier setting BI-AMP

Use this feature to activate or deactivate the bi-amplifier function (see page 16).

Choices: ON, OFF

- Select "ON" if you want to activate the bi-amplifier function. "SUR.B L/R SP" is set to "NONE" automatically, and this unit outputs the front channel audio signals at the SURROUND BACK/BI-AMP speaker terminals.
- Select "OFF" if you want to deactivate the bi-amplifier function.

#### Note

When "BI-AMP" is set to "ON", you can only select "FRONT B", "ZONE B", or "NONE" in "EXTRA SP ASSIGN" (see page 68).

### ■ SCENE IR code setting SCENE IR

Use this feature to output the remote control signals at the REMOTE OUT jack automatically when this unit is in the SCENE mode.

Choices: ON, OFF

- Select "ON" when the component connected to the REMOTE OUT jack is the Yamaha component and has the capability of the SCENE control signals. This unit automatically sends the remote control signals to the component.
- Select "OFF" when the component connected to the REMOTE OUT jack is not the Yamaha component and does not have the capability of the SCENE control signals.

#### Note

If noises are output when you operate the SCENE function, set "SCENE IR" to "OFF".

### ■ Parameter initialization INIT

Use this feature to reset the parameters of this unit to the initial factory settings. You can select the category of parameters to be initialized.

Choices: DSP PARAM, VIDEO, ALL, CANCEL

- Select "DSP PARAM" to initialize all the parameters of the sound field programs (see page 56).
- Select "VIDEO" to initialize the parameters in "VIDEO SET" (see page 80) and "OSD SHIFT" in "DISPLAY SET" (see page 79).
- Select "ALL" to initialize all the parameters of this unit.
- Select "CANCEL" to cancel the initialization procedure.

#### Note

Use "INITIALIZE" in the sound field program menu to initialize the parameters of the desired program (see page 56).

# Troubleshooting

Refer to the table below when this unit does not function properly. If the problem you are experiencing is not listed below or if the instruction below does not help, turn off this unit, disconnect the power cable, and contact the nearest authorized Yamaha dealer or service center.

## ■ General

Problem	Cause	Remedy	See page
<b>This unit fails to turn on or enters the standby mode soon after the power is turned on.</b>	The power cable is not connected or the plug is not completely inserted.	Connect the power cable firmly.	—
	The speaker impedance setting is incorrect.	Set the speaker impedance to match your speakers.	27
	The protection circuitry has been activated.	Make sure that all speaker wire connections on this unit and on all speakers are secure and that the wires for each connection do not touch anything other than their respective connections.	14
	This unit has been exposed to a strong external electric shock (such as lightning or strong static electricity).	Set this unit to the standby mode, disconnect the power cable, plug it back in after 30 seconds and then use this unit normally.	—
<b>No sound.</b>	Incorrect input or output cable connections.	Connect the cables properly. If the problem persists, the cables may be defective.	20-26
	The optimizer microphone is connected.	Disconnect the optimizer microphone.	34
	Audio input jack select is set to "HDMI", "COAX/OPT" or "ANALOG".	Set Audio input jack select to "AUTO".	43
	Audio input jack select is set to "ANALOG" while playing a source encoded in Dolby Digital or DTS.	Set Audio input jack select to "AUTO" or "COAX/OPT".	43
	No appropriate input source has been selected.	Select an appropriate input source with the INPUT selector on the front panel (or the input selector buttons on the remote control).	41, 42
	Speaker connections are not secure.	Secure the connections.	14
	The front speakers to be used have not been selected properly.	Select the front speakers by pressing <b>(A) SPEAKERS</b> on the front panel repeatedly.	42
	The volume is turned down.	Turn up the volume.	—
	The sound is muted.	Press <b>(M) MUTE</b> or <b>(V) VOLUME +/-</b> on the remote control to resume audio output and then adjust the volume.	44
	Signals this unit cannot reproduce are being input from a source component, such as a CD-ROM.	Play a source whose signals can be reproduced by this unit.	—
	The HDMI components connected to this unit do not support the HDCP copy protection standards.	Connect HDMI components that support the HDCP copy protection standards.	18
	"S.AUDIO" is set to "OTHER" and "HDMI" audio signals are not being played back on this unit.	Set "S.AUDIO" to "DSP-AX763" in "MANUAL SETUP".	81
<b>No picture.</b>	The output and input for the picture are connected to different types of video jacks.	Set "VIDEO CONV." to "ON" or connect your source components in the same way as you connect your video monitor to this unit.	80
	Non-standard video signals are input.		
<b>The sound suddenly goes off.</b>	The protection circuitry has been activated because of a short circuit, etc.	Check that the speaker impedance setting is correct. Check that the speaker wires are not touching each other and then turn this unit back on.	27, 94 —
	The sleep timer has turned this unit off.	Turn this unit on, and play the source again.	—
	The sound is muted.	Press <b>(M) MUTE</b> or <b>(V) VOLUME +/-</b> on the remote control to resume audio output.	44
<b>Sound is heard from the speaker on one side only.</b>	Incorrect cable connections.	Connect the cables properly. If the problem persists, the cables may be defective.	14
	Incorrect settings in "SP LEVEL".	Adjust the "SP LEVEL" settings.	70

Problem	Cause	Remedy	See page
<b>Only the center speaker outputs substantial sound.</b>	When playing a monaural source with a sound field program, the source signal is directed to the center channel, and the front and surround speakers output effect sounds.		
<b>No sound is heard from the center speaker.</b>	“CENTER SP” in “SET MENU” is set to “NONE”.	Set “CENTER SP” to “SMALL” or “LARGE”.	69
	One of the sound field programs (except for “7ch Stereo”) has been selected.	Try another sound field program.	47
<b>No sound is heard from the presence speakers.</b>	The sound field programs are turned off.	Press <b>Ⓢ</b> STRAIGHT to turn them on.	50
	You are using a source or program combination that does not output sound from all channels.	Try another sound field program.	41
	“EXTRA SP ASSIGN” is set to a setting other than “PRESENCE”.	Set “EXTRA SP ASSIGN” to “PRESENCE”.	68
<b>No sound is heard from the surround speakers.</b>	“SUR. L/R SP” in “SET MENU” is set to “NONE”.	Set “SUR. L/R SP” to “SML” or “LRG”.	69
	This unit is in the “Straight” mode and a monaural source is being played back.	Press <b>Ⓢ</b> STRAIGHT on the front panel so that “Straight” disappears from the front panel display.	50
<b>No sound is heard from the surround back speakers.</b>	“SUR. L/R SP” in “SET MENU” is set to “NONE” and “SUR.B L/R SP” is automatically set to “NONE”.	Set “SUR. L/R SP” and “SUR.B L/R SP” to a setting other than “NONE”.	69
	“SUR.B L/R SP” in “SET MENU” is set to “NONE”.	Set “SUR.B L/R SP” to a setting other than “NONE”.	69
<b>FRONT B speakers cannot be activated.</b>	“EXTRA SP ASSIGN” is set to a setting other than “FRONT B”.	Set “EXTRA SP ASSIGN” to “FRONT B”.	68
<b>No sound from the center, surround or surround back speakers when the FRONT B speakers are activated.</b>	“EXTRA SP ASSIGN” is set to “ZONE B”.	Set “EXTRA SP ASSIGN” to “FRONT B”.	68
<b>Presence speaker settings are not available in “SET MENU”.</b>	“EXTRA SP ASSIGN” is set to a setting other than “PRESENCE”.	Set “EXTRA SP ASSIGN” to “PRESENCE”.	68
<b>No sound is heard from the subwoofer.</b>	“LFE/BASS OUT” in “SET MENU” is set to “FRONT” when a Dolby Digital or DTS signal is being played.	Set “LFE/BASS OUT” to “SWFR” or “BOTH”.	68
	“LFE/BASS OUT” in “SET MENU” is set to “SWFR” or “FRONT” when a 2-channel source is being played.	Set “LFE/BASS OUT” to “BOTH”.	68
	The source does not contain low-frequency signals.		
<b>Dolby Digital or DTS sources cannot be played. (Dolby Digital or DTS indicator in the front panel display does not light up.)</b>	The connected component is not set to output Dolby Digital or DTS digital signals.	Make an appropriate setting following the operating instructions for your component.	—
	Audio input jack select is set to “ANALOG”.	Set Audio input jack select to “AUTO”.	43
<b>A humming sound is heard.</b>	Incorrect cable connections.	Connect the audio cables firmly. If the problem persists, the cables may be defective.	—
	No connection from the turntable to the GND terminal.	Connect the grounding cable of your turntable to the GND terminal of this unit.	23
<b>The volume level is low while a record is being played.</b>	The record is being played on a turntable with an MC cartridge.	Connect your turntable to this unit through an MC-head amplifier.	23
<b>The volume level cannot be increased, or the sound is distorted.</b>	The component connected to the AUDIO OUT (REC) jacks of this unit is turned off.	Turn on the power of the component.	—

Problem	Cause	Remedy	See page
<b>The sound effects cannot be recorded.</b>	It is not possible to record the sound effects with a recording component.		
<b>A source cannot be recorded by a digital recording component connected to the DIGITAL OUTPUT jack.</b>	The source component is not connected to the DIGITAL INPUT jacks of this unit. Some components cannot record Dolby Digital or DTS sources.	Connect the source component to the DIGITAL INPUT jacks.	21, 23
<b>A source cannot be recorded by an analog component connected to the AUDIO OUT (REC) jacks.</b>	The source component is not connected to the analog AUDIO IN jacks of this unit.	Connect the source component to the analog AUDIO IN jacks.	23
<b>The sound field parameters and some other settings of this unit cannot be changed.</b>	“MEMORY GUARD” in “SET MENU” is set to “ON”.	Set “MEMORY GUARD” to “OFF”.	80
<b>This unit does not operate properly.</b>	The internal microcomputer has been frozen by an external electric shock (such as lightning or excessive static electricity) or by a power supply with low voltage.	Disconnect the power cable from the AC wall outlet and then plug it in again after about 30 seconds.	—
<b>No sound is heard from the connected HDMI component.</b>	The HDMI component does not accept the multi-channel audio signals.	Convert the multi-channel audio signals to the 2-channel audio signals at the source component such as a DVD player.	—
<b>“CHECK SP WIRES” appears in the front panel display.</b>	Speaker cables are short-circuited.	Make sure all speaker cables are connected correctly.	14
<b>There is noise interference from digital or radio frequency equipment.</b>	This unit is too close to the digital or high-frequency equipment.	Move this unit further away from such equipment.	—
<b>The picture is disturbed.</b>	The video source uses scrambled or encoded signals to prevent dubbing.		
<b>This unit suddenly enters the standby mode.</b>	The internal temperature is too high and the overheat protection circuitry has been activated.	Wait about 1 hour for this unit to cool down and then turn it back on.	—

## ■ HDMI

Problem	Cause	Remedy	See page
<b>No picture or sound.</b>	The number of the connected HDMI components is over the limit.	Reduce the number of the connected HDMI components.	—
	HDCP authentication failed.	Check that the connected HDMI components support the HDCP copy protection standards.	—

■ Remote control

Problem	Cause	Remedy	See page
<b>The remote control does not work or function properly.</b>	Wrong distance or angle.	The remote control will function within a maximum range of 6 m and no more than 30 degrees off-axis from the front panel.	30
	Direct sunlight or lighting (from an inverter type of fluorescent lamp, etc.) is striking the remote control sensor of this unit.	Reposition this unit.	—
	The batteries are weak.	Replace all batteries.	4
	The operation mode selector is set incorrectly.	Set the operation mode selector correctly. When operating this unit, set it to the <b>ⓂAMP</b> position. When operating the component selected by the input selector button, set it to the <b>ⓂSOURCE</b> position. When operating the TV set in the <b>ⓂDTV/CBL</b> or <b>ⓂPHONO</b> area, set it to the <b>ⓂTV</b> position.	—
	The remote control code was not correctly set.	Set the remote control code correctly using “List of remote control codes” at the end of this manual.	84
		Try setting another code of the same manufacturer using “List of remote control codes” at the end of this manual.	84
	The library code of the remote control and the remote control ID of this unit do not match.	Match the remote control ID of this unit with the corresponding remote control library code.	95
Even if the remote control code is correctly set, there are some models that do not respond to the remote control.	Program the necessary functions independently into the programmable buttons using the Learn feature.	86	
<b>The remote control does not learn new functions.</b>	The batteries of this remote control and/or the other remote control are too weak.	Replace the batteries.	4
	The distance between the two remote controls is too much or too little.	Place the remote controls at the proper distance.	86
	The signal coding or modulation of the other remote control is not compatible with this remote control.	Learning is not possible.	—
	Memory capacity is full.	Delete other unnecessary functions to make room for the new functions.	92

## ■ iPod

### Note

In case of a transmission error without a status message appearing in the front panel and in the OSD, check the connection to your iPod (see page 25).

Status message	Cause	Remedy	See page
Loading...	This unit is in the middle of recognizing the connection with your iPod. This unit is in the middle of acquiring song lists from your iPod.		
Connect error	There is a problem with the signal path from your iPod to this unit.	Turn off this unit and reconnect the Yamaha iPod universal dock to the DOCK terminal of this unit. Try resetting your iPod.	25 —
Unknown iPod	The iPod being used is not supported by this unit.	Only iPod (Click and Wheel), iPod nano, and iPod mini are supported.	—
iPod connected	Your iPod is properly stationed in a Yamaha iPod universal dock (such as YDS-10, sold separately) connected to the DOCK terminal of this unit, and the connection between your iPod and this unit is complete.		
Disconnected	Your iPod was removed from a Yamaha iPod universal dock (such as YDS-10 sold separately) connected to the DOCK terminal of this unit.	Station your iPod back in a Yamaha iPod universal dock (such as YDS-10 sold separately) connected to the DOCK terminal of this unit.	25
Unable to play	This unit cannot play back the songs currently stored on your iPod.	Check that the songs currently stored on your iPod are playable. Store some other playable music files on your iPod.	— —

## ■ Bluetooth

Status message	Cause	Remedy	See page
Searching...	The Bluetooth adapter and the Bluetooth component is in the middle of the pairing. The Bluetooth adapter and the Bluetooth component is in the middle of establishing the connection.		
Completed	The pairing is completed.		
Canceled	The pairing is canceled.		
BT connected	The connection between the Yamaha Bluetooth adapter (such as YBA-10, sold separately) and the Bluetooth component is established.		
Disconnected	The Bluetooth component is disconnected from the Yamaha Bluetooth adapter (such as YBA-10, sold separately).		
No BT adapter	The Bluetooth adapter is not connected to the DOCK terminal.	Connect the Yamaha Bluetooth adapter (such as YBA-10, sold separately) to the DOCK terminal.	25
Not found	Yamaha Bluetooth adapter (such as YBA-10, sold separately) could not find any Bluetooth components.		
Not Available	Another Bluetooth connection has already been established.	Terminate the existing connection.	54

## ■ AUTO SETUP

### Before AUTO SETUP

Error message	Cause	Remedy	See page
Connect MIC!	Optimizer microphone is not connected.	Connect the supplied optimizer microphone to the OPTIMIZER MIC jack on the front panel.	31
Unplug HP!	Headphones are connected.	Unplug the headphones.	—
Memory Guard!	The parameters of this unit are protected.	Set "MEMORY GUARD" to "OFF".	80

### During AUTO SETUP

Error message	Cause	Remedy	See page
E-1:NO FRONT SP	Front L/R channel signals are not detected.	Check the front L/R speaker connections.	14
E-2:NO SUR SP	A surround channel signal is not detected.	Check the surround speaker connections.	14
E-3:NO PRNS SP	A presence channel signal is not detected.	Check the presence speaker connections.	14
E-4:SBR->SBL	Only a right surround back channel signal is detected.	Connect the surround back speaker to the LEFT SURROUND BACK SPEAKERS terminal if you only have one surround back speaker.	14
E-5:NOISY	Background noise is too loud.	Try running "AUTO SETUP" in a quiet environment. Turn off noisy electric equipment like air conditioners or move them away from the optimizer microphone.	— —
E-6:CHECK SUR.	Surround back speakers are connected, though surround L/R speakers are not.	Connect surround speakers when you use surround back speakers.	14
E-7:NO MIC	The optimizer microphone was unplugged during the "AUTO SETUP" procedure.	Connect the supplied optimizer microphone to the OPTIMIZER MIC jack on the front panel.	31
E-8:NO SIGNAL	The optimizer microphone does not detect test tones.	Check the microphone setting. Check the speaker connections and placement.	31 14
E-9:USER CANCEL	The "AUTO SETUP" procedure was cancelled due to user activity.	Run "AUTO SETUP" again.	31
E-10:INTERNAL ERROR	An internal error occurred.	Run "AUTO SETUP" again.	31



After AUTO SETUP

Warning message	Cause	Remedy	See page
W-1: OUT OF PHASE	Speaker polarity is not correct. This message may appear depending on the speakers even when the speakers are connected correctly.	Check the speaker connections for proper polarity (+ or -).	14
W-2: OVER 24m (80ft)	The distance between the speaker and the listening position is over 24 m (80 ft).	Bring the speaker closer to the listening position.	—
W-3: LEVEL ERROR	The difference of volume level among speakers is excessive.	Readjust the speaker installation so that all speakers are set in locations with similar conditions.	—
		Check the speaker connections.	14
		Use speakers of similar quality.	—
		When “SWFR: TOO LOUD” or “SWFR: TOO LOW” appears in the result screen, the output volume of the subwoofer.	31
W-4: CHECK PRMS	“EXTRA SP ASSIGN” is set to “PRESENCE”, though the presence channel signals are not detected.	Check the presence speaker connections.	14
		Set “EXTRA SP ASSIGN” to a setting other than “PRESENCE”.	32

**Notes**

- If the “ERROR” or “WARNING” screens appears, check the cause of the problem, then run “AUTO SETUP” again.
- If a warning message “W-1”, “W-2”, or “W-3” appears, corrections are made, but they may not be optimal.
- If an error message “E-10” occurs repeatedly, contact a qualified Yamaha service center.

# Resetting the system

Use this feature to reset all the parameters of this unit to the initial factory settings.

## Notes

- This procedure completely resets all the parameters of this unit including the “SET MENU” parameters.
- The initial factory settings are activated next time you turn on this unit.



To cancel the initialization procedure at any time without making any changes, press **Ⓢ** **STANDBY/ON** on the front panel.

---

**1** Press **Ⓢ** **STANDBY/ON** on the front panel to set this unit to the standby mode.

---

**2** Press and hold **Ⓢ** **TONE CONTROL** and then press **Ⓢ** **STANDBY/ON** to turn on this unit.

This unit turns on, and the advanced setup menu appears in the front panel display.



---

**3** Rotate the **Ⓢ** **PROGRAM** selector to select “INIT”.

---

**4** Press **Ⓢ** **TONE CONTROL** repeatedly to select “ALL”.



Select “CANCEL” to cancel the initialization procedure without making any changes.

---

**5** Press **Ⓢ** **STANDBY/ON** to confirm your selection and set this unit to the standby mode.

# Glossary

## ■ Audio and video synchronization (lip sync)

Lip sync, an abbreviation for lip synchronization, is a technical term that involves both a problem and a capability of maintaining audio and video signals synchronized during post-production and transmission. Whereas the audio and video latency requires complex end-user adjustments, HDMI version 1.3 incorporates an automatic audio and video syncing capability that allows devices to perform this synchronization automatically and accurately without user interaction.

## ■ Bi-amplification connection

A bi-amplification connection uses two amplifiers for a speaker. One amplifier is connected to the woofer section of a loudspeaker while the other is connected to the combined mid and tweeter section. With this arrangement each amplifier operates over a restricted frequency range. This restricted range presents each amplifier with a much simpler job and each amplifier is less likely to influence the sound in some way. The internal crossover of the speaker consists of a LPF (low pass filter) and a HPF (high pass filter). As its name implies, the LPF passes frequencies below a cutoff and rejects frequencies above the cutoff frequency. Likewise, the HPF passes frequencies above its cutoff.

## ■ Component video signal

With the component video signal system, the video signal is separated into the Y signal for the luminance and the Pb and Pr signals for the chrominance. Color can be reproduced more faithfully with this system because each of these signals is independent. The component signal is also called the “color difference signal” because the luminance signal is subtracted from the color signal. A monitor with component input jacks is required in order to output component signals.

## ■ Composite video signal

With the composite video signal system, the video signal is composed of three basic elements of a video picture: color, brightness and synchronization data. A composite video jack on a video component transmits these three elements combined.

## ■ Deep Color

Deep Color refers to the use of various color depths in displays, up from the 24-bit depths in previous versions of the HDMI specification. This extra bit depth allows HDTVs and other displays go from millions of colors to billions of colors and eliminate on-screen color banding for smooth tonal transitions and subtle gradations between colors. The increased contrast ratio can represent many times more shades of gray between black and white. Also Deep Color increases the number of available colors within the boundaries defined by the RGB or YCbCr color space.

## ■ Dolby Digital

Dolby Digital is a digital surround sound system that gives you completely independent multi-channel audio. With 3 front channels (front L/R and center), and 2 surround stereo channels, Dolby Digital provides 5 full-range audio channels. With an additional channel especially for bass effects, called LFE (Low Frequency Effect), the system has a total of 5.1-channels (LFE is counted as 0.1 channel). By using 2-channel stereo for the surround speakers, more accurate moving sound effects and surround sound environment are possible than with Dolby Surround. The wide dynamic range from maximum to minimum volume reproduced by the 5 full-range channels and the precise sound orientation generated using digital sound processing provide listeners with unprecedented excitement and realism. With this unit, any sound environment from monaural up to a 5.1-channel configuration can be freely selected for your enjoyment.

## ■ Dolby Digital EX

Dolby Digital EX creates 6 full-bandwidth output channels from 5.1-channel sources. This is done using a matrix decoder that derives 3 surround channels from the 2 in the original recording. For the best results, Dolby Digital EX should be used with movie sound tracks recorded with Dolby Digital Surround EX. With this additional channel, you can experience more dynamic and realistic moving sound especially with scenes with “fly-over” and “fly-around” effects.

## ■ Dolby Digital Plus

Dolby Digital Plus is an advanced audio technology developed for high-definition programming and media including HD broadcasts, HD DVD, and Blu-ray Disc. Selected as a mandatory audio standard for HD DVD and as an optional audio standard for Blu-ray Disc, this technology delivers multichannel sound with discrete channel output. Supporting bitrates up to 6.0 Mbps, Dolby Digital Plus can carry up to 7.1 discreet audio channels simultaneously. Supported by HDMI version 1.3 and designed for the optical disc players and AV receivers/amplifiers of the future, Dolby Digital Plus also remains fully compatible with the existing multichannel audio systems that incorporate Dolby Digital.

## ■ Dolby Pro Logic II

Dolby Pro Logic II is an improved technique used to decode vast numbers of existing Dolby Surround sources. This new technology enables a discrete 5-channel playback with 2 front left and right channels, 1 center channel, and 2 surround left and right channels instead of only 1 surround channel for conventional Pro Logic technology. There are three modes available: “Music mode” for music sources, “Movie mode” for movie sources and “Game mode” for game sources.

## ■ Dolby Pro Logic IIx

Dolby Pro Logic IIx is a new technology enabling discrete multi-channel playback from 2-channel or multi-channel sources. There are three modes available: “Music mode” for music sources, “Movie mode” for movie sources (for 2-channel sources only) and “Game mode” for game sources.

## ■ Dolby Surround

Dolby Surround uses a 4-channel analog recording system to reproduce realistic and dynamic sound effects: 2 front left and right channels (stereo), a center channel for dialog (monaural), and a surround channel for special sound effects (monaural). The surround channel reproduces sound within a narrow frequency range. Dolby Surround is widely used with nearly all video tapes and laser discs, and in many TV and cable broadcasts as well. The Dolby Pro Logic decoder built into this unit employs a digital signal processing system that automatically stabilizes the volume on each channel to enhance moving sound effects and directionality.

## ■ Dolby TrueHD

Dolby TrueHD is an advanced lossless audio technology developed for high-definition disc-based media including HD DVD and Blu-ray Disc. Selected as a mandatory audio standard for HD DVD and as an optional audio standard for Blu-ray Disc, this technology delivers sound that is bit-for-bit identical to the studio master, offering a high-definition home theater experience. Supporting bitrates up to 18.0 Mbps, Dolby TrueHD can carry up to 8 discrete channels of 24-bit/96 kHz audio simultaneously. Supported by HDMI version 1.3 and designed for the optical disc players and AV receivers/amplifiers of the future, Dolby TrueHD also remains fully compatible with the existing multichannel audio systems and retains the metadata capability of Dolby Digital, allowing dialog normalization and dynamic range control.

## ■ DSD

Direct Stream Digital (DSD) technology stores audio signals on digital storage media, such as Super Audio CDs. Using DSD, signals are stored as single bit values at a high-frequency sampling rate of 2.8224 MHz, while noise shaping and oversampling are used to reduce distortion, a common occurrence with very high quantization of audio signals. Due to the high sampling rate, better audio quality can be achieved than that offered by the PCM format used for normal audio CDs.

## ■ DTS 96/24

DTS 96/24 offers an unprecedented level of audio quality for multi-channel sound on DVD video, and is fully backward-compatible with all DTS decoders. “96” refers to a 96 kHz sampling rate compared to the typical 48 kHz sampling rate. “24” refers to 24-bit word length. DTS 96/24 offers sound quality transparent to the original 96/24 master, and 96/24 5.1-channel sound with full-quality full-motion video for music programs and motion picture soundtracks on DVD video.

## ■ DTS Digital Surround

DTS digital surround was developed to replace the analog soundtracks of movies with a 6.1-channel digital sound track, and is now rapidly gaining popularity in movie theaters around the world. DTS, Inc. has developed a home theater system so that you can enjoy the depth of sound and natural spatial representation of DTS digital surround in your home. This system produces practically distortion-free 6.1-channel sound (technically, front left and right, center, surround left and right, and LFE 0.1 (subwoofer) channels for a total of 5.1 channels). This unit incorporates a DTS-ES decoder that enables 6.1-channel reproduction by adding the surround back channel to the existing 5.1-channel format.

## ■ DTS Express

DTS Express is an advanced audio technology for the optional feature on Blu-ray Disc or HD DVD, which offers high-quality, low bit rate audio optimized for network streaming, and Internet applications. DTS Express is used for the Secondary Audio feature of Blu-ray Disc or the Sub Audio feature of HD DVD. These features deliver audio commentaries (for example, the additional commentaries made by the director of a film) on demand by the users via the Internet, etc. DTS Express signals are mixed down with the main audio stream on the player component, and the component sends the mixed audio stream to the AV receivers/amplifiers via digital coaxial, digital optical, or analog connections.

## ■ DTS-HD High Resolution Audio

DTS-HD High Resolution Audio is a high resolution audio technology developed for high-definition disc-based media including HD DVD and Blu-ray Disc. Selected as an optional audio standard for both HD DVD and Blu-ray Disc, this technology delivers sound that is virtually indistinguishable from the original, offering a high-definition home theater experience. Supporting bitrates up to 3.0 Mbps for HD DVD and 6.0 Mbps for Blu-ray Disc, DTS-HD High Resolution Audio can carry up to 7.1 discrete channels of 24-bit/96 kHz audio simultaneously. Supported by HDMI version 1.3 and designed for the optical disc players and AV receivers/amplifiers of the future, DTS-HD High Resolution Audio also remains fully compatible with the existing multichannel audio systems that incorporate DTS Digital Surround.

## ■ DTS-HD Master Audio

DTS-HD Master Audio is an advanced lossless audio technology developed for high-definition disc-based media including HD DVD and Blu-ray Disc. Selected as a mandatory audio standard for both HD DVD and Blu-ray Disc, this technology delivers sound that is bit-for-bit identical to the studio master, offering a high-definition home theater experience. Supporting bitrates up to 18.0 Mbps for HD DVD and up to 24.5 Mbps for Blu-ray Disc, DTS-HD Master Audio can carry up to 7.1 discrete channels of 24-bit/96 kHz audio simultaneously. Supported by HDMI version 1.3 and designed for the optical disc players and AV receivers/amplifiers of the future, DTS-HD Master Audio also remains fully compatible with the existing multichannel audio systems that incorporate DTS Digital Surround.

## ■ HDMI

HDMI (High-Definition Multimedia Interface) is the first industry-supported, uncompressed, all-digital audio/video interface. Providing an interface between any source (such as a set-top box or AV receiver) and an audio/video monitor (such as a digital television), HDMI supports standard, enhanced or high-definition video as well as multi-channel digital audio using a single cable. HDMI transmits all ATSC HDTV standards and supports 8-channel digital audio, with bandwidth to spare to accommodate future enhancements and requirements. When used in combination with HDCP (High-bandwidth Digital Content Protection), HDMI provides a secure audio/video interface that meets the security requirements of content providers and system operators. For further information on HDMI, visit the HDMI website at “<http://www.hdmi.org/>”.

### ■ LFE 0.1 channel

This channel reproduces low-frequency signals. The frequency range of this channel is from 20 Hz to 120 Hz. This channel is counted as 0.1 because it only enforces a low-frequency range compared to the full-range reproduced by the other 5/6 channels in Dolby Digital or DTS 5.1/6.1-channel systems.

### ■ Neo:6

Neo:6 decodes the conventional 2-channel sources for 6-channel playback by the specific decoder. It enables playback with the full-range channels with higher separation just like digital discrete signal playback. There are two modes available: "Music mode" for music sources and "Cinema mode" for movie sources.

### ■ PCM (Linear PCM)

Linear PCM is a signal format under which an analog audio signal is digitized, recorded and transmitted without using any compression. This is used as a method of recording CDs and DVD audio. The PCM system uses a technique for sampling the size of the analog signal per very small unit of time. Standing for "Pulse Code Modulation", the analog signal is encoded as pulses and then modulated for recording.

### ■ Sampling frequency and number of quantized bits

When digitizing an analog audio signal, the number of times the signal is sampled per second is called the sampling frequency, while the degree of fineness when converting the sound level into a numeric value is called the number of quantized bits. The range of rates that can be played back is determined based on the sampling rate, while the dynamic range representing the sound level difference is determined by the number of quantized bits. In principle, the higher the sampling frequency, the wider the range of frequencies that can be played back, and the higher the number of quantized bits, the more finely the sound level can be reproduced.

### ■ S-video signal

With the S-video signal system, the video signal normally transmitted using a pin cable is separated and transmitted as the Y signal for the luminance and the C signal for the chrominance through the S-video cable. Using the S VIDEO jack eliminates video signal transmission loss and allows recording and playback of even more beautiful images.

### ■ "x.v.Color"

A color space standard supported by HDMI version 1.3. It is a more extensive color space than sRGB, and allows the expression of colors that could not be expressed before. While remaining compatible with the color gamut of sRGB standards, "x.v.Color" expands the color space and can thus produce more vivid, natural images. It is particularly effective for still pictures and computer graphics.

# Sound field program information

## ■ Elements of a sound field

What really creates the rich, full tones of a live instrument are the multiple reflections from the walls of the room. In addition to making the sound live, these reflections enable us to tell where the player is situated as well as the size and shape of the room in which we are sitting.

There are two distinct types of sound reflections that combine to make up the sound field in addition to the direct sound coming straight to our ears from the player's instrument.

### Early reflections

Reflected sounds reach our ears extremely rapidly (50 ms to 100 ms after the direct sound), after reflecting from one surface only (for example, from a wall or the ceiling).

Early reflections actually add clarity to the direct sound.

### Reverberations

These are caused by reflections from more than one surface (for example, from the walls, and the ceiling) so numerous that they merge together to form a continuous sonic afterglow. They are non-directional and lessen the clarity of the direct sound.

Direct sound, early reflections and subsequent reverberations taken together help us to determine the subjective size and shape of the room, and it is this information that the digital sound field processor reproduces in order to create sound fields.

If you could create the appropriate early reflections and subsequent reverberations in your listening room, you would be able to create your own listening environment. The acoustics in your room could be changed to those of a concert hall, a dance floor, or a room with virtually any size at all. This ability to create sound fields at will is exactly what Yamaha has done with the digital sound field processor.

## ■ CINEMA DSP

Since the Dolby Surround and DTS systems were originally designed for use in movie theaters, their effect is best felt in a theater having many speakers designed for acoustic effects. Since home conditions, such as room size, wall material, number of speakers, and so on, can differ so widely, it is inevitable that there are differences in the sound heard. Based on a wealth of actually measured data, Yamaha CINEMA DSP uses Yamaha original sound field technology to combine Dolby Pro Logic, Dolby Digital and DTS systems to provide the audiovisual experience of a movie theater in the listening room of your own home.

## ■ SILENT CINEMA

Yamaha has developed a natural, realistic sound effect DSP algorithm for headphones. Parameters for headphones have been set for each sound field so that accurate representations of all the sound field programs can be enjoyed on headphones.

## ■ Virtual CINEMA DSP

Yamaha has developed a Virtual CINEMA DSP algorithm that allows you to enjoy DSP sound field surround effects even without any surround speakers by using virtual surround speakers. It is even possible to enjoy Virtual CINEMA DSP using a minimal two-speaker system that does not include a center speaker.

## ■ Compressed Music Enhancer

The Compressed Music Enhancer feature of this unit enhances your listening experience by regenerating the missing harmonics in a compression artifact. As a result, flattened complexity due to the loss of high-frequency fidelity as well as lack of bass due to the loss of low-frequency bass is compensated, providing improved performance of the overall sound system.

# Specifications

## AUDIO SECTION

- Minimum RMS Output Power for Front, Center, Surround, Surround back  
20 Hz to 20 kHz, 0.06% THD, 8 Ω ..... 95 W
- Dynamic Power (IHF)  
Front L/R, 8/6/4/2 Ω ..... 130/165/195/240 W
- Maximum Output Power  
Speaker impedance setting: 8 Ω, 1 kHz, 0.7% THD, 4 Ω ..... 145 W
- IEC Output Power  
Front L/R, 1 kHz, 0.06% THD, 8 Ω ..... 105 W
- Damping Factor (IHF)  
Front L/R, SPEAKERS A, 20 Hz to 20 kHz, 8 Ω ..... 120 or more
- Input Sensitivity/Input Impedance  
PHONO (MM) ..... 3.5 mV/47 kΩ  
CD, etc. .... 200 mV/47 kΩ  
MULTI CH INPUT ..... 200 mV/47 kΩ
- Maximum Input Voltage  
PHONO (MM)  
1 kHz, 0.1% THD ..... 60 mV or more  
CD, etc.  
Effect On, 1 kHz, 0.5% THD ..... 2.3 V or more
- Rated Output Voltage/Output Impedance  
OUT (REC) ..... 200 mV/1.2 kΩ  
PRE OUT ..... 1.0 V/1.2 kΩ  
SUBWOOFER (2ch Stereo, FRONT SP: SMALL) ..... 1.0 V/1.2 kΩ
- Headphone Jack Rated Output/Impedance  
CD, etc. (1 kHz, 50 mV, 8 Ω) ..... 150 mV/100 Ω
- Frequency Response  
CD to Front L/R, 10 Hz to 100 kHz ..... +0/-3 dB
- RIAA Equalization Deviation  
PHONO (MM) ..... 0 ± 0.5 dB
- Total Harmonic Distortion  
PHONO (MM) to OUT (REC)  
20 Hz to 20 kHz, 1 V ..... 0.02% or less  
CD, etc. to Front L/R  
2ch Stereo, 20 Hz to 20 kHz, 50 W, 8 Ω ..... 0.06% or less
- Signal to Noise Ratio (IHF-A Network)  
PHONO (MM, 5 mV) to OUT (REC) ..... 81 dB or more  
CD, etc. (Effect Off, 250 mV) to Front L/R ..... 100 dB or more
- Residual Noise (IHF-A Network)  
Front L/R ..... 150 μV or less
- Channel Separation (1 kHz/10 kHz)  
PHONO (shortened) to Front L/R ..... 60 dB/55 dB or more  
CD, etc. (5.1 kΩ shortened) to Front L/R ..... 60 dB/45 dB or more

- Volume Control ..... MUTE/-80 dB to 16.5 dB
- Tone Control (Front L/R)  
BASS Boost/Cut ..... ±10 dB/50 Hz  
BASS Turnover Frequency ..... 350 Hz  
TREBLE Boost/Cut ..... ±10 dB/20 kHz  
TREBLE Turnover Frequency ..... 3.5 kHz
- Filter Characteristics (fc=40/60/80/90/100/110/120/160/200 Hz)  
H.P.F.  
(FRONT SP, CENTER SP, SUR. L/R SP, SUR.B L/R SP:  
SMALL/SML) ..... 12 dB/oct.  
L.P.F. (Subwoofer) ..... 24 dB/oct.

## VIDEO SECTION

- Video Format (Gray Back) ..... PAL
- Video Format (Video Conversion) ..... NTSC/PAL
- Signal Level  
Composite ..... 1 V<sub>p-p</sub>/75 Ω  
S-video ..... 1 V<sub>p-p</sub>/75 Ω (Y), 0.286 V<sub>p-p</sub>/75 Ω (C)  
Component ..... 1 V<sub>p-p</sub>/75 Ω (Y), 0.7 V<sub>p-p</sub>/75 Ω (P<sub>B</sub>/P<sub>R</sub>)
- Maximum Input Level (Video Conversion Off) ..... 1.5 V<sub>p-p</sub> or more
- Signal to Noise Ratio ..... 50 dB or more
- Frequency Response (MONITOR OUT)  
Component (Video Conversion Off) ..... 5 Hz to 100 MHz, -3 dB

## GENERAL

- Power Supply ..... AC 230 V, 50 Hz
- Power Consumption ..... 440 W
- Standby Power Consumption ..... 0.1 W or less
- AC Outlets ..... 1 (100 W maximum)
- Dimensions (W x H x D) ..... 435 x 171 x 393 mm  
(17-1/8 x 6-3/4 x 15-1/2 in)
- Weight ..... 11.8 kg (26 lbs 4 oz)

\* Specifications are subject to change without notice.

# Index

## ■ Numerics

1 BASIC MENU, Manual setup .....	63
2 VOLUME MENU, Manual setup .....	64
2ch STEREO, Sound field program .....	49
3 SOUND MENU, Manual setup .....	64
4 INPUT MENU, Manual setup .....	65
5 OPTION MENU, Manual setup .....	65
7ch Enhancer, Sound field program .....	49
7ch STEREO, Sound field program .....	49
96/24 indicator .....	29

## ■ A

A)DISPLAY SET, Option menu .....	79
A)EQUALIZER, Sound menu .....	73
A)SPEAKER SET, Basic menu .....	68
AC OUTLET (SWITCHED) .....	27
Action Game, Sound field program .....	48
ADAPTIVE DRC indicator .....	29
ADAPTIVE DRC, Volume menu .....	72
ADAPTIVE DSP LEVEL, Volume menu .....	72
Adaptive DSP level, Volume menu .....	72
Adaptive dynamic range control, Volume menu .....	72
Advanced setup .....	94
Advanced sound configurations .....	56
Adventure, Sound field program .....	49
Amplifier function OSD display time, Display settings .....	79
ANALOG RES., Video information .....	45
Audio and video synchronization, Sound menu .....	75
Audio cable plugs .....	17
Audio components connection .....	23
Audio information .....	45
Audio input jacks selection .....	43
AUDIO jacks .....	17
Audio jacks .....	17
AUDIO SELECT .....	43
AUDIO SELECT, Initial configuration .....	81
Audio select, Initial configuration .....	81
Audio signal flow .....	19
AUTO DELAY, Lip sync .....	75
Auto delay, Lip sync .....	75
AUTO SETUP .....	31, 63
Auto setup .....	63
AUTO SETUP, Troubleshooting .....	102
Available decoders with Sound field programs .....	61

## ■ B

B)LFE LEVEL, Sound menu .....	74
B)SP LEVEL, Basic menu .....	70
BASIC MENU, Manual setup .....	68
Basic menu, Manual setup .....	63
Bass cross over, Speaker settings .....	70
BGV, Input menu .....	78
BI-AMP, Advanced setup .....	96
Bi-Amplifier, Advanced setup .....	96

BITRATE, Audio information .....	45
Bluetooth adapter connection .....	25
Bluetooth component playback .....	54
Bluetooth component use .....	54
Bluetooth, Troubleshooting .....	101
BT connected, Bluetooth status message .....	101

## ■ C

C)DYNAMIC RANGE, Sound menu .....	74
C)MEMORY GUARD, Option menu .....	80
C)SP DISTANCE, Basic menu .....	71
Cable plugs .....	17
Canceled, Bluetooth status message .....	101
CD player connection .....	23
CD recorder connection .....	23
Cellar Club, Sound field program .....	48
CENTER PRE OUT jack connection .....	24
CENTER SP, Speaker settings .....	69
Center speaker level, Sound field parameter .....	61
Center speaker, Speaker settings .....	69
CENTER WIDTH, Decoder parameter .....	62
Chamber, Sound field program .....	47
CHANNEL, Audio information .....	45
Charge on standby, Input menu .....	77
CHECK PRNS, Automatic setup warning message .....	103
CHECK SP WIRES .....	14
CHECK SUR., Automatic setup error message .....	102
CINEMA DSP indicator .....	29
CLASSICAL, Sound field category .....	47
Clear settings, Remote control .....	91
CLEAR, Remote control .....	91
Completed, Bluetooth status message .....	101
COMPONENT VIDEO jacks .....	17
Compressed Music Enhancer .....	49
Connect error, iPod status message .....	101
Connect MIC!, Automatic setup error message .....	102
Connection, audio components .....	23
Connection, Bluetooth adapter .....	25
Connection, CD player .....	23
Connection, CD recorder .....	23
Connection, CENTER PRE OUT jack .....	24
Connection, DVD player .....	21
Connection, DVD recorder .....	22
Connection, External amplifier .....	24
Connection, external decoder .....	25
Connection, FRONT PRE OUT jacks .....	24
Connection, iPod universal dock .....	25
Connection, MD recorder .....	23
Connection, Multi-format player .....	25
Connection, Power cable .....	27
Connection, projector .....	20

Connection, PVR .....	22
Connection, set-top boxes .....	22
Connection, speaker cable .....	16
Connection, SUBWOOFER PRE OUT jack .....	24
Connection, SUR.BACK PRE OUT jacks .....	24
Connection, SURROUND PRE OUT jacks .....	24
Connection, Tape deck .....	23
Connection, Tuner .....	23
Connection, Turntable .....	23
Connection, TV monitor .....	20
Connection, VCR .....	22
CROSS OVER, Speaker settings .....	70
CT LEVEL, Sound field parameter .....	61
Current status display .....	43

## ■ D

D)INIT. CONFIG, Option menu .....	81
D)LIPSYNC, Sound menu .....	75
D)TEST TONE, Basic menu .....	71
Decoder descriptions .....	62
Decoder indicators .....	29
DECODER MODE, Initial configuration .....	81
Decoder mode, Initial configuration .....	81
DECODER MODE, Input menu .....	77
Decoder mode, Input menu .....	77
Decoder selection .....	61
DEVICE OVER, HDMI error message .....	45
DIALG.LIFT, Sound field parameter .....	57
Dialogue lift, Sound field parameter .....	57
DIGITAL COAXIAL jacks .....	17
DIGITAL OPTICAL jacks .....	17
DIMENSION, Decoder parameter .....	62
DIMMER, Display settings .....	79
Dimmer, Display settings .....	79
DIRECT, Sound field parameter .....	61
Disconnected, Bluetooth status message .....	101
Disconnected, iPod status message .....	101
Display settings, Option menu .....	79
DIST, Auto setup result .....	33
DOCK indicator .....	29
Drama, Sound field program .....	49
DSP effect level, Sound field parameter .....	57
DSP indicators .....	29
DSP LEVEL, Sound field parameter .....	57
DVD player connection .....	21
DVD recorder connection .....	22
Dynamic range, Sound menu .....	74

## ■ E

E)EXTD SUR., Sound menu .....	75
E)HDMI SET, Option menu .....	81
E-1:NO FRONT SP, Automatic setup error message .....	102



- E-10:INTERNAL ERROR, Automatic setup error message ..... 102
- E-2:NO SUR SP, Automatic setup error message ..... 102
- E-3:NO PRNS SP, Automatic setup error message ..... 102
- E-4:SBR->SBL, Automatic setup error message ..... 102
- E-5:NOISY, Automatic setup error message ..... 102
- E-6:CHECK SUR., Automatic setup error message ..... 102
- E-7:NO MIC, Automatic setup error message ..... 102
- E-8:NO SIGNAL, Automatic setup error message ..... 102
- E-9:USER CANCEL, Automatic setup error message ..... 102
- EFFECT LEVEL,  
Sound field parameter ..... 61
- ENHANCER indicator ..... 29
- ENTERTAINMENT,  
Sound field category ..... 48
- EQ TYPE SELECT, Equalizer ..... 73
- EQ, Auto setup parameter ..... 32
- Equalizer type select, Equalizer ..... 73
- Equalizer, Sound menu ..... 73
- EXTD SUR., Initial configuration ..... 81
- Extended surround,  
Initial configuration ..... 81
- Extended surround, Sound menu ..... 75
- External amplifier connection ..... 24
- External decoder connection ..... 25
- EXTRA SP ASSIGN, Auto setup parameter ..... 32
- EXTRA SP ASSIGN,  
Speaker settings ..... 68
- Extra speaker assignment,  
Auto setup parameter ..... 32
- Extra speaker assignment,  
Speaker settings ..... 68
- **F**
- FL SCROLL, Display settings ..... 79
- FLAG, Audio information ..... 45
- FORMAT, Audio information ..... 45
- Front panel display ..... 29
- Front panel display scroll,  
Display settings ..... 79
- FRONT PRE OUT jack connection ..... 24
- FRONT SP, Speaker settings ..... 69
- Front speaker set selection ..... 42
- Front speakers, Speaker settings ..... 69
- FRONT, Input menu ..... 78
- **G**
- GEQ, Equalizer ..... 73
- Graphic equalizer, Equalizer ..... 73
- **H**
- Hall in Munich,  
Sound field program ..... 47
- Hall in Vienna,  
Sound field program ..... 47
- HDCP ERROR,  
HDMI Error message ..... 45
- HDMI ..... 18
- HDMI AUTO, Lip sync ..... 75
- HDMI auto, Lip sync ..... 75
- HDMI error and message ..... 45
- HDMI ERROR, Video information ..... 45
- HDMI indicator ..... 29
- HDMI RES., Video information ..... 45
- HDMI set, Option menu ..... 81
- HDMI SIGNAL, Video information ..... 45
- HDMI, troubleshooting ..... 99
- HEADPHONE, Dynamic range ..... 74
- HEADPHONE,  
Low frequency effect level ..... 74
- Headphones ..... 44
- Headphones indicator ..... 29
- Headphones, Dynamic range ..... 74
- Headphones,  
Low frequency effect level ..... 74
- **I**
- I/O ASSIGNMENT, Input menu ..... 76
- Infrared window ..... 30
- INIT, Advanced setup ..... 96
- INIT.DLY, Sound field parameter ..... 58
- INIT.VOL., Volume menu ..... 72
- Initial configuration, Option menu ..... 81
- Initial delay, Sound field parameter ..... 58
- Initial volume, Volume menu ..... 72
- INPUT CH, Input menu ..... 78
- Input channel and speaker indicators ..... 30
- Input channel indicators ..... 30
- INPUT MENU, Manual setup ..... 76
- Input menu, Manual setup ..... 65
- INPUT RENAME, Input menu ..... 77
- Input rename, Input menu ..... 77
- Input signal indicators ..... 29
- Input source indicators ..... 29
- Input source information display ..... 45
- Input/output assignment, Input menu ..... 76
- INTERNAL ERROR,  
Automatic setup error message ..... 102
- iPod connected,  
iPod status message ..... 101
- iPod universal dock connection ..... 25
- iPod use ..... 52
- iPod, Trouble shooting ..... 101
- **J**
- Jacks ..... 17
- **L**
- LEARN, Remote control ..... 86
- Learning, Remote control settings ..... 86
- LEVEL ERROR, Automatic setup warning message ..... 103
- LFE/BASS OUT, Speaker settings ..... 68
- LFE/Bass out, Speaker settings ..... 68
- Lip Sync, Sound menu ..... 75
- LIVE/CLUB, Sound field category ..... 48
- LIVENESS, Sound field parameter ..... 59
- Liveness, Sound field parameter ..... 59
- Loading, iPod status message ..... 101
- Low-frequency effect level,  
Sound menu ..... 74
- LVL, Auto setup result ..... 33
- **M**
- Macro programming,  
Remote control settings ..... 88
- MANUAL DELAY, Lip sync ..... 75
- Manual delay, Lip sync ..... 75
- MANUAL SETUP ..... 63
- Manual setup ..... 63
- MAX VOL., Volume menu ..... 72
- Maximum volume ..... 72
- Maximum volume, Volume menu ..... 72
- MCR ?, Remote control ..... 90
- MD recorder connection ..... 23
- Memory Guard!, Automatic setup error message ..... 102
- Memory guard, Option menu ..... 80
- Mono Movie, Sound field program ..... 49
- MOVIE, Sound field category ..... 48
- MULTI CH INPUT  
component selection ..... 42
- MULTI CH INPUT jacks ..... 25
- Multi-channel input BGV,  
Input menu ..... 78
- Multi-channel input channels,  
Input menu ..... 78
- Multi-channel input front left and right channel input jack, Input menu ..... 78
- Multi-channel source playback with headphones ..... 50
- Multi-format player connection ..... 25
- Multi-information display ..... 30
- MUSIC ENHANCER,  
Sound field category ..... 49
- Music Video, Sound field program ..... 48
- MUTE ..... 44
- MUTE indicator ..... 29
- MUTE TYPE, Volume menu ..... 72
- Muting ..... 44
- Muting type, Volume menu ..... 72
- **N**
- Neo:6 Cinema, Decoder type ..... 61, 62
- Neo:6 Music, Decoder type ..... 62
- No BT Adapter,  
Bluetooth status message ..... 101
- NO FRONT SP, Automatic setup error message ..... 102
- NO MIC, Automatic setup error message ..... 102
- NO PRNS SP, Automatic setup error message ..... 102
- NO SIGNAL, Automatic setup error message ..... 102
- NO SUR SP, Automatic setup error message ..... 102
- NOISY, Automatic setup error message ..... 102
- Not Available,  
Bluetooth status message ..... 101
- Not found,  
Bluetooth status message ..... 101

- Number of speakers,
  - Auto setup result ..... 33
- **O**
- Operation mode selector ..... 30
- OPTIMIZER MIC jack ..... 31
- Optimizing the speaker setting for
  - your listening room ..... 31
- OPTION MENU, Manual setup ..... 79
- Option menu, Manual setup ..... 65
- OPTN, Remote control ..... 84
- OSD SHIFT, Display settings ..... 79
- OSD shift, Display settings ..... 79
- OSD-AMP, Display settings ..... 79
- OSD-SOURCE, Display settings ..... 79
- OUT OF PHASE, Automatic setup
  - warning message ..... 103
- Out of Res., HDMI message ..... 45
- OVER 24m (80ft), Automatic setup
  - warning message ..... 103
- **P**
- P.INIT.DLY, Sound field parameter ..... 58
- P.ROOM SIZE,
  - Sound field parameter ..... 59
- Pairing, Bluetooth operation ..... 54
- PANORAMA, Decoder parameter ..... 62
- Parameter initialization,
  - Advanced setup ..... 96
- Parametric equalizer type,
  - Auto setup parameter ..... 32
- PHONES jack ..... 44
- PL LEVEL, Sound field parameter ..... 61
- Playing video sources in the
  - background ..... 44
- PLII Game, Decoder type ..... 62
- PLII Movie, Decoder type ..... 61, 62
- PLII Music, Decoder type ..... 62
- PLIIX Game, Decoder type ..... 62
- PLIIX Movie, Decoder type ..... 61, 62
- PLIIX Music, Decoder type ..... 62
- Power cable connection ..... 27
- PR LEVEL, Sound field parameter ..... 61
- Presence left speaker level,
  - Sound field parameter ..... 61
- Presence right speaker level,
  - Sound field parameter ..... 61
- Presence sound field initial delay,
  - Sound field parameter ..... 58
- Presence sound field room size,
  - Sound field parameter ..... 59
- Presence speaker indicators ..... 30
- Presence speaker using ..... 13
- Preset SCENE templates ..... 38
- Pro Logic, Decoder type ..... 62
- Projector connection ..... 20
- Pure Direct ..... 51
- Pure hi-fi sound ..... 51
- PVR connection ..... 22
- **R**
- Rear panel ..... 10
- REMOTE AMP, Advanced setup ..... 95
- Remote control AMP ID,
  - Advanced setup ..... 95
- Remote control code setting ..... 84
- Remote control, Trouble shooting ..... 100
- REMOTE OUT jack ..... 26
- Rename, SCENE template ..... 39
- Repeat ..... 53
- Repeat, iPod playback ..... 53
- Resetting the system ..... 104
- REV.DELAY, Sound field parameter ..... 60
- REV.LEVEL, Sound field parameter ..... 60
- REV.TIME, Sound field parameter ..... 60
- Reverberation delay,
  - Sound field parameter ..... 60
- Reverberation level,
  - Sound field parameter ..... 60
- Reverberation time,
  - Sound field parameter ..... 60
- Roleplaying Game,
  - Sound field program ..... 48
- ROOM SIZE, Sound field parameter ..... 59
- Room size, Sound field parameter ..... 59
- **S**
- S VIDEO jacks ..... 17
- S.Audio, HDMI set ..... 81
- S.INIT.DLY, Sound field parameter ..... 58
- S.LIVENESS, Sound field parameter ..... 59
- S.ROOM SIZE,
  - Sound field parameter ..... 59
- SAMPLING, Audio information ..... 45
- SB INI.DLY, Sound field parameter ..... 58
- SB LEVEL, Sound field parameter ..... 61
- SB LIVENESS,
  - Sound field parameter ..... 59
- SB ROOM SIZE,
  - Sound field parameter ..... 59
- SBR->SBL, Automatic setup
  - error message ..... 102
- SCENE 1 ..... 8
- SCENE 2 ..... 8
- SCENE 3 ..... 8
- SCENE 4 ..... 8
- SCENE IR code setting,
  - Advanced setup ..... 96
- SCENE IR, Advanced setup ..... 96
- SCENE template rename ..... 39
- Sci-Fi, Sound field program ..... 48
- Selection, Audio input jacks ..... 43
- Selection, Front speaker set ..... 42
- Selection,
  - MULTI CH INPUT component ..... 42
- Selection, SCENE template ..... 36
- SET MENU usage ..... 67
- Set-top box connection ..... 22
- Shuffle, iPod playback ..... 53
- SIGNAL INFO ..... 45
- Signal information ..... 66
- SILENT CINEMA ..... 50
- SILENT CINEMA indicator ..... 29
- SL LEVEL, Sound field parameter ..... 61
- SLEEP indicator ..... 30
- Sleep timer ..... 46
- Sound field indicators ..... 29
- Sound field parameter changing ..... 56
- Sound field programs ..... 47
- Sound field programs with
  - headphones ..... 50
- Sound field programs without
  - surround speakers ..... 50
- SOUND MENU, Manual setup ..... 73
- Sound menu, Manual setup ..... 64
- Source feature OSD display time,
  - Display settings ..... 79
- source name setting, Remote control
  - settings ..... 87
- SP A B indicators ..... 29
- SP IMP., Advanced setup ..... 94
- SP, Auto setup result ..... 33
- Speaker cable connection ..... 16
- Speaker distance, Auto setup result ..... 33
- Speaker distance, Basic menu ..... 71
- Speaker distances ..... 71
- Speaker impedance setting ..... 27
- Speaker impedance, Advanced setup ..... 94
- Speaker level adjustment ..... 51
- Speaker level, Auto setup result ..... 33
- Speaker level, Basic menu ..... 70
- Speaker settings, Basic menu ..... 68
- SPEAKER, Dynamic range ..... 74
- SPEAKER,
  - Low frequency effect level ..... 74
- Speakers, Dynamic range ..... 74
- Speakers, Low frequency effect level ..... 74
- Specifications ..... 109
- Spectacle, Sound field program ..... 48
- Sports, Sound field program ..... 48
- SR LEVEL, Sound field parameter ..... 61
- Standard, Sound field program ..... 48
- STANDBY CHARGE, Input menu ..... 77
- START PAIRING, Input menu ..... 78
- Start pairing, Input menu ..... 78
- STEREO, Sound field category ..... 49
- Straight ..... 50
- Straight Enhancer,
  - Sound field program ..... 49
- Straight mode ..... 50
- SUBWOOFER PHASE,
  - Speaker settings ..... 70
- Subwoofer phase, Speaker settings ..... 70
- SUBWOOFER PRE OUT
  - jack connection ..... 24
- Supplied accessories ..... 2
- Support audio, HDMI set ..... 81
- SUR. L/R SP, Speaker settings ..... 69
- SUR.B L/R SP, Speaker settings ..... 69
- SUR.BACK PRE OUT
  - jack connection ..... 24
- Surround back left/right speakers,
  - Speaker settings ..... 69
- Surround back sound field initial delay,
  - Sound field parameter ..... 58
- Surround back sound field liveness,
  - Sound field parameter ..... 59
- Surround back sound field room size,
  - Sound field parameter ..... 59
- Surround back speaker level,
  - Sound field parameter ..... 61

- Surround decode mode ..... 61
- Surround left speaker level,  
Sound field parameter ..... 61
- Surround left/right speakers,  
Speaker settings ..... 69
- SURROUND PRE OUT  
jack connection ..... 24
- Surround right speaker level,  
Sound field parameter ..... 61
- Surround sound field initial delay,  
Sound field parameter ..... 58
- Surround sound field liveness,  
Sound field parameter ..... 59
- Surround sound field room size,  
Sound field parameter ..... 59
- **T**
- Tape deck connection ..... 23
- Test tone, Basic menu ..... 71
- Test tone, Equalizer ..... 73
- TEST, Equalizer ..... 73
- The Bottom Line,  
Sound field program ..... 48
- The Roxy Theatre,  
Sound field program ..... 48
- Tonal quality adjustment ..... 51
- Transmit indicator ..... 30
- Troubleshooting ..... 97
- Tuner connection ..... 23
- Turning off ..... 28
- Turning on ..... 28
- Turntable connection ..... 23
- TV controlling by remote control ..... 82
- TV monitor connection ..... 20
- **U**
- Unable to play, iPod status message ..... 101
- UNIT, Speaker distance ..... 71
- Unit, Speaker distance ..... 71
- Unknown iPod,  
iPod status message ..... 101
- Unplug HP!, Automatic setup  
error message ..... 102
- Unprocessed input sources ..... 50
- USER CANCEL, Automatic setup  
error message ..... 102
- **V**
- VCR connection ..... 22
- VIDEO AUX jacks ..... 26
- VIDEO CONV., Video settings ..... 80
- Video conversion, Video settings ..... 80
- Video information ..... 45
- VIDEO jacks ..... 17
- Video jacks ..... 17
- VIDEO SET, Option menu ..... 80
- Video settings, Option menu ..... 80
- Video signal flow ..... 19
- Video sources in the background ..... 44
- Virtual CINEMA DSP ..... 50
- VIRTUAL indicator ..... 29
- VOL. TRIM, Input menu ..... 77
- VOLUME level indicator ..... 29
- VOLUME MENU, Manual setup ..... 72
- Volume menu, Manual setup ..... 64
- Volume Trim, Input menu ..... 77
- **W**
- W-1:OUT OF PHASE, Automatic setup  
warning message ..... 103
- W-2:OVER 24m (80ft), Automatic setup  
warning message ..... 103
- W-3:LEVEL ERROR, Automatic setup  
warning message ..... 103
- W-4:CHECK PRNS, Automatic setup  
warning message ..... 103
- **Y**
- YPAO indicator ..... 29
- **Z**
- Zone B ..... 42

“(A)SPEAKERS” or “(B)DVD”  
(example) indicates the name of  
the parts on the front panel or the  
remote control. Refer to the  
attached sheet or the pages at the  
end of this manual for the  
information about each position of  
the parts.

## Limited Guarantee for European Economic Area (EEA) and Switzerland

Thank you for having chosen a Yamaha product. In the unlikely event that your Yamaha product needs guarantee service, please contact the dealer from whom it was purchased. If you experience any difficulty, please contact Yamaha representative office in your country. You can find full details on our website (<http://www.yamaha-hifi.com/> or <http://www.yamaha-uk.com/> for U.K. resident).

The product is guaranteed to be free from defects in workmanship or materials for a period of two years from the date of the original purchase. Yamaha undertakes, subject to the conditions listed below, to have the faulty product or any part(s) repaired, or replaced at Yamaha's discretion, without any charge for parts or labour. Yamaha reserves the right to replace a product with that of a similar kind and/or value and condition, where a model has been discontinued or is considered uneconomic to repair.

### Conditions

1. The original invoice or sales receipt (showing date of purchase, product code and dealer's name) MUST accompany the defective product, along with a statement detailing the fault. In the absence of this clear proof of purchase, Yamaha reserves the right to refuse to provide free of charge service and the product may be returned at the customer's expense.
2. The product MUST have been purchased from an AUTHORISED Yamaha dealer within the European Economic Area (EEA) or Switzerland.
3. The product must not have been the subject of any modifications or alterations, unless authorised in writing by Yamaha.
4. The following are excluded from this guarantee:
  - a. Periodic maintenance and repair or replacement of parts due to normal wear and tear.
  - b. Damage resulting from:
    - (1) Repairs performed by the customer himself or by an unauthorised third party.
    - (2) Inadequate packaging or mishandling, when the product is in transit from the customer. Please note that it is the customer's responsibility to ensure the product is adequately packaged when returning the product for repair.
    - (3) Misuse, including but not limited to (a) failure to use the product for its normal purpose or in accordance with Yamaha's instructions on the proper use, maintenance and storage, and (b) installation or use of the product in a manner inconsistent with the technical or safety standards in force in the country where it is used.
    - (4) Accidents, lightning, water, fire, improper ventilation, battery leakage or any cause beyond Yamaha's control.
    - (5) Defects of the system into which this product is incorporated and/or incompatibility with third party products.
    - (6) Use of a product imported into the EEA and/or Switzerland, not by Yamaha, where that product does not conform to the technical or safety standards of the country of use and/or to the standard specification of a product sold by Yamaha in the EEA and/or Switzerland.
    - (7) Non AV (Audio Visual) related products.  
(Products subject to "Yamaha AV Guarantee Statement" are defined in our website at <http://www.yamaha-hifi.com/> or <http://www.yamaha-uk.com/> for U.K. resident.)
5. Where the guarantee differs between the country of purchase and the country of use of the product, the guarantee of the country of use shall apply.
6. Yamaha may not be held responsible for any losses or damages, whether direct, consequential or otherwise, save for the repair or replacement of the product.
7. Please backup any custom settings or data, as Yamaha may not be held responsible for any alteration or loss to such settings or data.
8. This guarantee does not affect the consumer's statutory rights under applicable national laws in force or the consumer's rights against the dealer arising from their sales/purchase contract.

## ■ Front panel

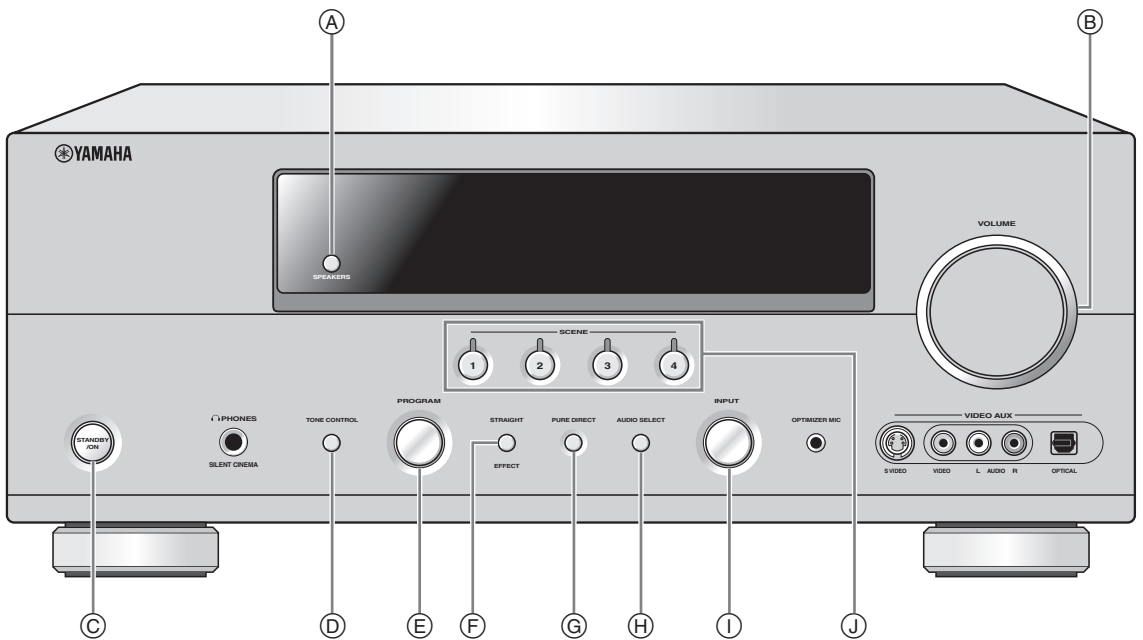

## ■ Remote control

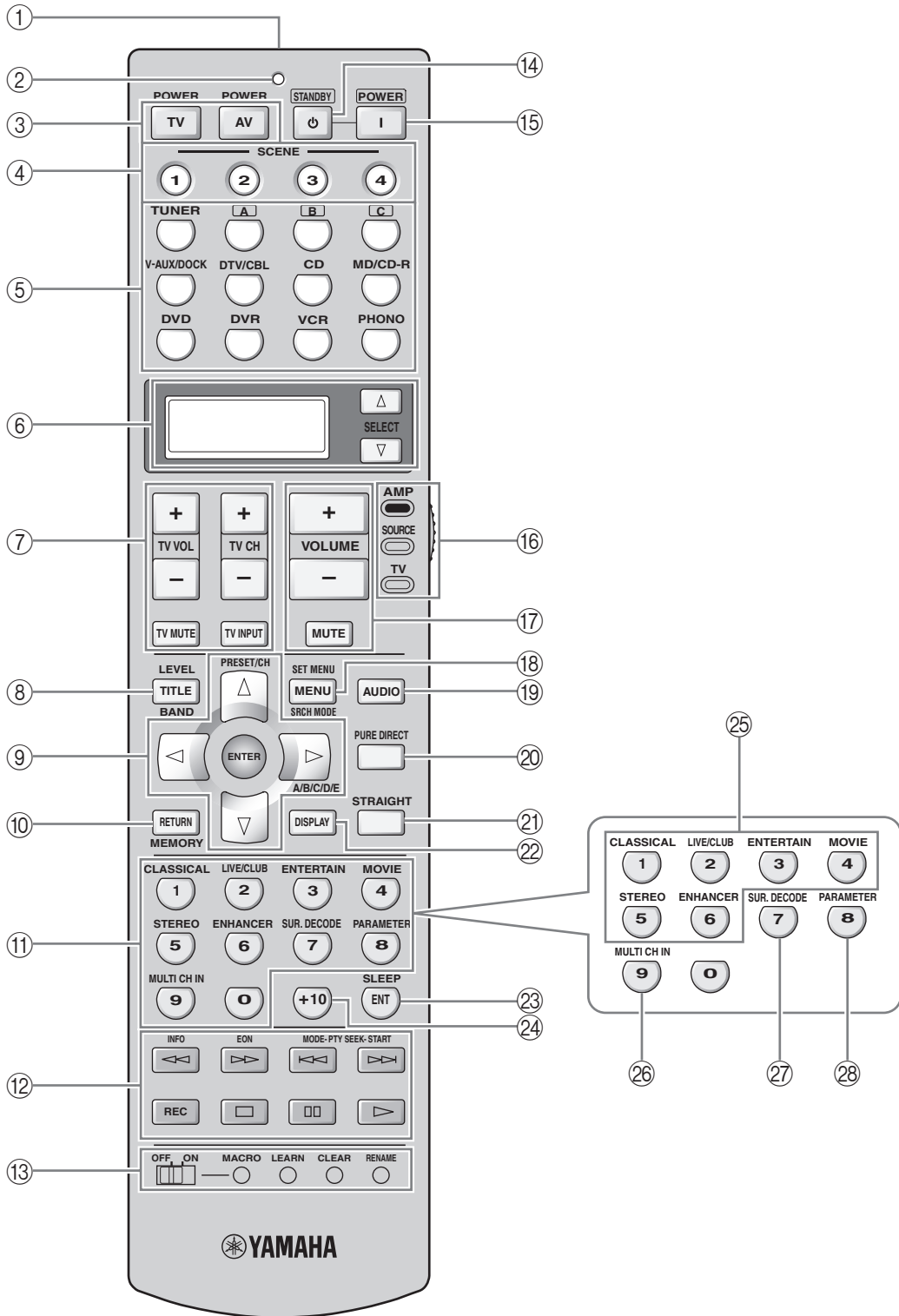

## List of remote control codes

### CABLE

ABC 0030, 0035  
 AMERICAST 0926  
 BELL SOUTH 0926  
 BIRMINGHAM CABLE COMMUNICATI  
 ONS 0303  
 BRITISH TELECOM 0030  
 CABLE & WIRELESS 1095  
 DAERYUNG 0035, 0504, 0904,  
 1904  
 DIRECTOR 0503  
 FILMNET 0470  
 GENERAL INSTRUMENT 0030, 0303, 0503,  
 0837,  
 GOLDSTAR 0171  
 HAMLIN 0036, 0300  
 JERROLD 0030, 0303, 0503,  
 0837  
 LG 0171  
 MNET 0470  
 MEMOREX 0027  
 MOTOROLA 0303, 0503, 0837,  
 1133  
 NTL 1095  
 NOOS 0844  
 ONO 1095  
 PVP STEREO VISUAL MATRIX 0030  
 PACE 0264, 1087, 1095  
 PANASONIC 0027, 0035, 0134  
 PARAGON 0027  
 PHILIPS 0332, 0344  
 PIONEER 0171, 0560, 0904,  
 1904  
 PULSAR 0027  
 QUASAR 0027  
 REGAL 0300, 0306  
 RUNCO 0027  
 SAGEM 0844  
 SAMSUNG 0027, 0171  
 SCIENTIFIC ATLANTA 0035, 0504, 0904,  
 1904  
 SONY 1033  
 STARCOM 0030  
 SUPERCABLE 0303  
 TS 0030  
 TELE+1 0470  
 TELEWEST 1095  
 TORX 0030  
 TOSHIBA 0027  
 TRANS PX 0303  
 UNITED CABLE 0030  
 ZENITH 0027, 0552, 0926

### CD PLAYER

AIWA 0184  
 ARCAM 0184  
 AUDIO RESEARCH 0184  
 AUDIO TON 0184  
 AUDIOLAB 0184  
 AUDIOMECA 0184

CAIRN 0184  
 CALIFORNIA AUDIO LABS 0056  
 CARVER 0184, 0206  
 CYRUS 0184  
 DKK 0027  
 DMX ELECTRONICS 0184  
 DENON 0900  
 DYNAMIC BASS 0206  
 EMERSON 0332  
 FISHER 0206  
 GENEXXA 0059, 0332  
 GOODMAN'S 0332  
 GRUNDIG 0184  
 HARMAN/KARDON 0184, 0200  
 HITACHI 0059  
 JVC 0099  
 KENWOOD 0055, 0064  
 KRELL 0184  
 LXI 0332  
 LINN 0184  
 MCS 0056  
 MAGNAVOX 0184, 0332  
 MARANTZ 0056, 0184  
 MATSUI 0184  
 MEMOREX 0332  
 MERIDIAN 0184  
 MICROMEGA 0184  
 MIRO 0027  
 MISSION 0184  
 MYRYAD 0184  
 NAD 0027  
 NSM 0184  
 NAIM 0184  
 OPTIMUS 0027, 0059, 0064,  
 0206, 0332  
 PANASONIC 0056  
 PHILIPS 0184  
 PIONEER 0059, 0332  
 POLK AUDIO 0184  
 PROTON 0184  
 QED 0184  
 QUAD 0184  
 QUASAR 0056  
 RCA 0059, 0206, 0332  
 REALISTIC 0206  
 REVOX 0184  
 ROTEL 0184  
 SAE 0184  
 SANSUI 0184, 0332  
 SANYO 0206  
 SCOTT 0332  
 SEARS 0332  
 SHARP 0064  
 SIMAUDIO 0184  
 SONIC FRONTIERS 0184  
 SONY 0027  
 SYMPHONIC 0332  
 TAG MCLAREN 0184  
 TANDY 0059  
 TECHNICS 0056  
 THORENS 0184  
 THULE 0184  
 UNIVERSUM 0184  
 VICTOR 0099  
 WARDS 0184  
 YAMAHA 2300, 2301

### CD RECORDER

KENWOOD 0653  
 MARANTZ 0653  
 PHILIPS 0653  
 YAMAHA 2400

### DVD PLAYER

ACOUSTIC SOLUTIONS 0757  
 ALBA 0744  
 AMSTRAD 0740  
 APEX DIGITAL 0699, 0744, 0782,  
 0821, 0823, 0857,  
 1127  
 BLAUPINKT 0744  
 BLUE PARADE 0598  
 BUSH 0740  
 CENTREX 0699  
 CLATRONIC 0815  
 CYBERHOME 0741  
 DVD2000 0548  
 DAEWOO 0811, 0797  
 DANSAI 0797  
 DECCA 0797  
 DENON 0517  
 DIAMOND 0795  
 DIGITREX 0699  
 EMERSON 0618  
 ENTERPRISE 0618  
 FISHER 0697  
 GE 0549, 0744  
 GO VIDEO 0742  
 GOLDSTAR 0768  
 GRADIENTE 0678  
 GREENHILL 0744  
 GRUNDIG 0566  
 HITACHI 0600, 0691  
 HITEKER 0699  
 JVC 0585, 0650  
 KLH 0744  
 KENWOOD 0517, 0561  
 KOSS 0678  
 LG 0768  
 LIMIT 0795  
 MAGNAVOX 0530, 0702  
 MARANTZ 0566  
 MEMOREX 0858  
 MICO 0750  
 MICROSOFT 0549  
 MINTEK 0744  
 MITSUBISHI 0548  
 MUSTEK 0757  
 NESA 0744  
 ONKYO 0530  
 ORITRON 0678  
 PALSONIC 0699  
 PANASONIC 0517, 0659, 1389  
 PHILIPS 0530, 0566, 0673,  
 0881  
 PIONEER 0552, 0598, 0658,  
 0659  
 POLK AUDIO 0566  
 PROSCAN 0549  
 QWESTAR 0678  
 RCA 0549, 0598, 0744  
 ROTEL 0650

### SM ELECTRONIC

0757  
 SAMSUNG 0600  
 SANYO 0697  
 SHARP 0657  
 SHERWOOD 0797  
 SHINSONIC 0560  
 SLIM ART 0811  
 SONY 0560, 0891  
 SYLVANIA 0702  
 TATUNG 0797  
 TEAC 0598, 0744  
 TECHNICS 0517  
 THETA DIGITAL 0598  
 THOMSON 0549  
 TOSHIBA 0530  
 URBAN CONCEPTS 0530  
 XBOX 0549  
 YAMAHA 0517, 0566, 0572,  
 2100  
 ZENITH 0530, 0618, 0768  
 ZEUS 0811

### Blu-ray Disc player

PANASONIC 2800, 2801, 2802  
 SAMSUNG 2816

### DVD RECORDER

PANASONIC 2800  
 YAMAHA 2807

### HD DVD PLAYER

TOSHIBA 2103

### LD PLAYER

CARVER 0091  
 DENON 0086  
 MARANTZ 0091  
 MITSUBISHI 0086  
 NAD 0086  
 NAGSMI 0086  
 OPTIMUS 0086  
 PHILIPS 0091  
 PIONEER 0086  
 SALORA 0091  
 SONY 0228  
 TELEFUNKEN 0086  
 YAMAHA 2200

### MD RECORDER

KENWOOD 0708  
 ONKYO 0895  
 SHARP 0888  
 SONY 0517  
 YAMAHA 2500, 2501, 2502

### RECEIVER (TUNER)

ADC 0558  
 AIWA 0185, 1116, 1415,  
 1432, 1668  
 ALCO 1417  
 ANAM 1636  
 APEX DIGITAL 1284

AUDIOLAB 1216  
 AUDIOTRONIC 1216  
 AUDIOVOX 1417  
 BOSE 1256  
 CAMBRIDGE SOUNDWORKS 1397  
 CAPETRONIC 0558  
 CARVER 1116, 1216  
 CENTREX 1284  
 DENON 1387  
 FERGUSON 0558  
 FINE ARTS 1216  
 GRUNDIG 1216  
 HARMAN/KARDON 0137, 1331  
 INTEGRA 0162, 1325  
 JBL 0137, 1333  
 JVC 0101, 0558, 1401, 1522  
 KLH 1417, 1439  
 KENWOOD 1054, 1340  
 MCS 0066  
 MAGNAVOX 0558, 1116, 1216, 1296,  
 MARANTZ 0066, 1116, 1216, 1316  
 MICROMEGA 1216  
 MUSICMAGIC 1116  
 MYRYAD 1216  
 NAD 0347  
 NORCENT 1416  
 ONKYO 0162, 0869, 1325  
 OPTIMUS 0558, 1050  
 PANASONIC 0066, 1315, 1545, 1790  
 PHILIPS 1116, 1216, 1293, 1295, 1296, 1310, 1316  
 PIONEER 0041, 0558, 1050, 1411  
 POLK AUDIO 1316  
 PROSCAN 1281  
 QUASAR 0066  
 RCA 0558, 1050, 1281, 1417, 1636,  
 SABA 0558  
 SANSUI 1116  
 SCHNEIDER 0558  
 SONY 0185, 1085, 1185, 1685, 1785  
 STEREOPHONICS 1050  
 SUNFIRE 1340  
 TEAC 1417  
 TECHNICS 0066, 1335, 1336, 1545  
 TELEFUNKEN 0558  
 THOMSON 1281  
 THORENS 1216  
 UHER 0558  
 VENTURER 1417  
 VICTOR 0101  
 WARDS 0041, 0185  
 YAMAHA 0203, 1203, 1358, 2601, 2608, 2609, 2611  
 (TUNER ID1) 2602  
 (TUNER ID2) 2610  
 (IPOD) 2606

## SATELLITE TUNER

@SAT 1327  
 ABSAT 0150  
 ALBA 0482  
 ALPHASTAR 0799  
 AMSTRAD 0874  
 ASTON 0169, 1156  
 ASTRO 0200  
 ATSAT 1327  
 AVALON 0423  
 BLAUPUNKT 0200  
 BRITISH SKY BROADCASTING 0874, 1202  
 CANAL DIGITAL 0880  
 CANAL SATELLITE 0880  
 CANAL+ 0880  
 CHAPARRAL 0243  
 CITYCOM 1203  
 CONNEXIONS 0423  
 CROSSDIGITAL 1136  
 CYRUS 0227  
 D-BOX 0750, 1154  
 DMT 1102  
 DNT 0227, 0423  
 DAERYUNG 0423  
 DAEWOO 1323  
 DIGENIUS 0326  
 DIRECTV 0274, 0419, 0593, 0666, 0751, 0776, 0846, 1103, 1136, 1169, 1776, 1883  
 DISH NETWORK SYSTEM 0802, 1032  
 DISHPRO 0802, 1032  
 DISTRATEL 0111  
 DREAM MULTIMEDIA 1264  
 ECHOSTAR 0194, 0423, 0637, 0802, 0880, 0898, 1032, 1113  
 ENGEL 1044  
 EXPRESSVU 0802  
 FTE 0890  
 FINLUX 0482  
 FRACARRO 0898  
 FUBA 0423  
 GE 0593  
 GOI 0802  
 GALAXIS 0890, 1138  
 GENERAL INSTRUMENT 0896  
 GOLD BOX 0880  
 GRUNDIG 0200, 0874  
 HTS 0802  
 HIRSCHMANN 0200, 0423  
 HITACHI 0482, 0846  
 HUGHES NETWORK SYSTEM 0776, 1169, 1776  
 HUMAX 0890, 1203  
 INVIDEO 0898  
 JVC 0802  
 KATHREIN 0150, 0200, 0227, 0276, 0685, 1248  
 KREISELMEYER 0200  
 LABGEAR 1323  
 LOGIX 1044  
 LORENZEN 0326  
 MAGNAVOX 0749, 0751

MANHATTAN 0482, 1044, 1110  
 MARANTZ 0227  
 MEDIASAT 0880  
 MEMOREX 0751  
 METRONIC 0111  
 MITSUBISHI 0776  
 MOTOROLA 0896  
 MYRYAD 0227  
 NEXT LEVEL 0896  
 NOKIA 0482, 0750, 0778, 1154, 1250, 1750  
 OCTALTV 1032  
 ORBITECH 1127  
 PACE 0482, 0874, 1202, 1350  
 PANASONIC 0274, 0728, 0874, 1347  
 PANDA 0482  
 PAYSAT 0751  
 PHILIPS 0160, 0227, 0482, 0749, 0751, 0776, 0880, 1103, 1169, 1776  
 PIONEER 0880  
 PROMAX 0482  
 PROSCAN 0419, 0593  
 RCA 0170, 0419, 0593, 0882  
 RFT 0227  
 RADIOSHACK 0896  
 RADIOLA 0227  
 RADIX 0423  
 SKY 0874, 0883, 1202  
 SM ELECTRONIC 1227  
 SABRE 0482  
 SAGEM 0847, 1141, 1280  
 SAMSUNG 1044, 1136, 1303, 1319  
 SAT CONTROL 1327  
 SATSTATION 1110  
 SCHWAIGER 1138  
 SEEMANN 0423  
 SIEMENS 0200  
 SONY 0666, 0874, 1666  
 STAR CHOICE 0896  
 STRONG 1327  
 TPS 0847, 1280  
 TANTEC 0482  
 TECHNISAT 1126, 1127  
 TELESTAR 1127  
 THOMSON 0482, 0880, 1073, 1318  
 TOPFIELD 1233  
 TOSHIBA 0776, 0817, 1776  
 ULTIMATETV 0419, 0666  
 UNIDEN 0749, 0751  
 UNIVERSUM 0200  
 VENTANA 0227  
 WISI 0200, 0423, 0482  
 XSAT 0150  
 ZEHNDER 1102  
 ZENITH 0883, 1883

HARMAN/KARDON 0056  
 MAGNAVOX 0056  
 MARANTZ 0056  
 MYRYAD 0056  
 OPTIMUS 0054  
 PHILIPS 0056  
 PIONEER 0054  
 POLK AUDIO 0056  
 RCA 0054  
 REVOX 0056  
 SANSUI 0056  
 SONY 0270  
 THORENS 0056  
 WARDS 0054  
 YAMAHA 2700, 2701

## TV

AGB 0543  
 AOC 0036, 0057, 0087, 0119, 0120, 0135, 0205, 0207, 0478  
 ASA 0131  
 AWA 0036  
 ACURA 0036  
 ADDISON 0119, 0135, 0680  
 ADMIRAL 0120, 0190, 0490  
 ADVENT 0788  
 AIKO 0119  
 AKAI 0036, 0057, 0235, 0388, 0543, 0729, 0839  
 AKURA 0291  
 ALBA 0036, 0064, 0398, 0695  
 AMERICA ACTION 0207  
 AMPRO 0778  
 AMSTRAD 0036, 0064, 0198, 0398, 0439, 0460, 0543  
 ANAM 0036, 0207, 0277  
 ANAM NATIONAL 0277, 0677  
 ANITECH 0036  
 APEX DIGITAL 0775, 0792, 0794  
 AUDIOSONIC 0064, 0136  
 BANG & OLUFSEN 0592  
 BASIC 0036  
 BAUR 0064, 0388, 0539  
 BAYSONIC 0207  
 BEAUMARK 0205  
 BEKO 0397, 0513, 0741, 0742  
 BELL & HOWELL 0181  
 BEON 0064  
 BLAUPUNKT 0222  
 BLUE SKY 0695, 1064  
 BONDSTEC 0274  
 BRADFORD 0207  
 BRANDT 0136, 0362  
 BROKSONIC 0263, 0490  
 BUSH 0036, 0064, 0398, 0401, 0695, 1064  
 CCE 0064  
 CGE 0274  
 CTC 0274  
 CXC 0207  
 CANDLE 0057  
 CARNIVALE 0057  
 CARVER 0081, 0197  
 CASCADE 0036

## TAPE DECK

AIWA 0056  
 CARVER 0056  
 GRUNDIG 0056



CATHAY	0064	FUTURETECH		KNEISSEL	0286, 0462	NORDMENDE	
CELEBRITY	0027		0207	KOLIN	0080, 0135, 0207		0136, 0314, 0587
CELERA	0792	GE	0057, 0074, 0078,	KORPEL	0064	OCEANIC	0190, 0388
CENTURION	0064		0119, 0205, 0207,	KOYODA	0036	ONWA	0207, 0460
CHANGHONG			0478, 0587, 1174,	L&S ELECTRONIC		OPTIMUS	0181, 0193, 0277,
	0792		1374, 1481		0835		0677
CHING TAI	0036, 0119	GEC	0064, 0543	LG	0057, 0064, 0087,	OPTONICA	0120
CHUN YUN	0027, 0036, 0119,	GATEWAY	1782, 1783		0135, 0205, 0741	ORION	0064, 0263, 0347,
	0207	GELOSO	0036	LXI	0074, 0081, 0181,		0490, 0543
CHUNG HSIN	0080, 0135, 0207	GENEXXA	0190		0183, 0205	OSAKI	0291, 0439
CIMLINE	0036	GIBRALTER	0044, 0057	LEYCO	0064, 0291	OTTO VERSAND	
CINERAL	0119, 0478	GOLDSTAR	0057, 0064, 0136,	LIESENK & TTER			0064, 0347, 0539,
CITIZEN	0057, 0087, 0119		0181, 0205, 0404		0064		0583
CLARION	0207	GOODMANS	0064, 0398, 0401,	LOEWE	0539	PALLADIUM	0397, 0445
CLARIVOX	0064		0661	LUXOR	0383, 0388	PANAMA	0291
CLATRONIC	0274, 0397	GOREMJE	0397	M ELECTRONIC		PANASONIC	0064, 0078, 0081,
CONDOR	0347, 0397	GRADIENTE	0080, 0197		0036, 0064, 0131,		0190, 0277, 0677,
CONRAC	0835	GRAETZ	0190, 0388		0132, 0136, 0190,		1437
CONTEC	0036, 0207	GRANADA	0064, 0235, 0366,		0314, 0373, 0401,	PATHE CINEMA	
CRAIG	0207		0543		0507		0265, 0347
CROSLEY	0081	GRANDIN	0637	MGA	0057, 0177, 0205	PAUSA	0036
CROWN	0036, 0064, 0207,	GRUNDIG	0064, 0222, 0514,	MTC	0057, 0087, 0539	PENNEY	0057, 0074, 0078,
	0397, 0445		0583, 0614	MAGNADYNE			0087, 0183, 0205,
CURTIS MATHES		GRUNPY	0207		0274, 0543		1374
	057, 0074, 0081,	HCM	0036, 0439	MAGNAFON	0543	PERDIO	0347
	0087, 0120, 0172,	HALLMARK	0205	MAGNAVOX	0057, 0081, 1281,	PHILCO	0057, 0064, 0081,
	0181, 0193, 0478,	HANKOOK	0057, 0205, 0207		1481		0172, 0205, 0207,
	0729, 1174, 1374	HANSEATIC	0064, 0347, 0388,	MANESTH	0291, 0347		0274, 0490, 1688
DAEWOO	0036, 0057, 0064,		0455, 0583	MARANTZ	0057, 0064, 0081,	PHILIPS	0027, 0057, 0064,
	0119, 0135, 0181,	HANTAREX	0543		0583		0078, 0081, 0119,
	0197, 0205, 0207,	HARMAN/KARDON		MARK	0064		0135, 0205, 0401,
	0401, 0478, 0650,		0081	MATSUI	0036, 0064, 0235,		0583, 0717, 1481
	0661, 1688	HARVARD	0207		0398, 0514, 0543	PHONOLA	0064
DANSAI	0064	HAVERMY	0120	MATSUSHITA		PILOT	0057
DAYTON	0036	HELLO KITTY			0277, 0677	PIONEER	0136, 0190, 0193,
DE GRAAF	0235, 0575		0478	MEDIATOR	0064		0314, 0706, 0787,
DECCA	0064, 0543	HINARI	0036, 0064	MEDION	0695, 0835, 1064		0893
DENON	0172	HISAWA	0482	MEGATRON	0172, 0205	PORTLAND	0119
DIGATRON	0064	HITACHI	0036, 0057, 0119,	MEMOREX	0036, 0177, 0181,	PRANDONI-PRINCE	
DIXI	0036, 0064		0132, 0136, 0172,		0205, 0277, 0490,		0543
DUMONT	0044		0190, 0205, 0252,		1064	PRIMA	0788
DWIN	0747, 0801		0383, 0508, 0575,	METZ	0474	PRISM	0078
ECE	0064		0605, 1172, 1283	MICROMAXX		PROFEX	0036, 0388
ELBE	0286	HUA TUN	0036		0835	PROSCAN	0074
ELECTROBAND		HUANYU	0401	MICROSTAR	0835	PROTECH	0036, 0064, 0274,
	0027	HYPSON	0064, 0291	MIDLAND	0044, 0074, 0078		0291, 0445, 0695
ELIN	0064, 0575	ICE	0291, 0398	MINERVA	0514	PROTON	0036, 0057, 0205
ELITE	0347	ITS	0398	MINOKA	0439	PULSAR	0044
ELTA	0036	ITT	0190, 0388, 0575	MITSUBISHI	0057, 0120, 0135,	QUASAR	0078, 0277, 0677
EMERSON	0181, 0205, 0207,	IMPERIAL	0274, 0397, 0445		0177, 0181, 0205,	QUELLE	0064, 0131, 0388,
	0263, 0388, 0490,	INDIANA	0064		0207, 0263, 0277,		0539
	0650	INFINITY	0081		0539, 0863, 1277	R-LINE	0064
ENVISION	0057, 0840	INGELEN	0190	MIVAR	0318, 0319, 0543,	RCA	0027, 0057, 0074,
EPSON	0860	INNO HIT	0543		0636		0117, 0119, 0205,
ERRES	0064	INNOVA	0064	MOTOROLA	0120		0706, 1074, 1174,
ETHER	0036, 0057	INTEQ	0044	MULTITECH	0036, 0207		1274, 1374, 1474,
ETRON	0036	INTERFUNK	0064, 0190, 0274,	MYRYAD	0583		1481, 1574
EUROPHON	0543		0388, 0539	NAD	0183, 0205, 0388,	RFT	0455
FERGUSON	0064, 0100, 0136,	INTERVISION			0893	RADIOSHACK	
	0265, 0314, 0362,		0064, 0291, 0404	NEC	0036, 0057, 0078,		0057, 0074, 0181,
	0587	JBL	0081		0181, 0183, 0197,		0205, 0207
FIDELITY	0388	JCB	0027		0205, 0482, 0524,	RADIOLA	0064
FINLANDIA	0235, 0373	JVC	0080, 0398, 0490,		1731	RADIOMARELLI	
FINLUX	0064, 0131, 0132,		0680, 0710	NEI	0064		0543
	0373, 0543	JEAN	0036, 0078, 0119,	NTC	0119	REALISTIC	0057, 0181, 0205,
FIRSTAR	0036, 0263		0183, 0263	NECKERMANN			0207
FIRSTLINE	0036, 0274, 0695	JENSEN	0788		0064, 0583	REDIFFUSION	
FISHER	0131, 0181, 0235,	KEC	0207	NETSAT	0064		0388
	0397	KTV	0057, 0207	NEWAVE	0036, 0119, 0120,	REOC	0741
FLINT	0482	KAISUI	0036		0205	REVOX	0064
FORMENTI	0064, 0347	KAPSCH	0190	NIKKAI	0064, 0291	REX	0190, 0286, 0291
FORTRESS	0120	KARCHER	0637	NIKKO	0057, 0119, 0205	ROADSTAR	0036, 0291, 0445
FRONTECH	0190, 0274, 0291	KATHREIN	0583	NOKIA	0388, 0500, 0507,	RUNCO	0044, 0057, 0524,
FUJITSU	0710, 0836	KENDO	0064		0575, 0658		0630
FUNAI	0207, 0198, 0291	KENWOOD	0057	NORCENT	0775, 0851	SBR	0064

SEG	0291, 0695	TAI YI	0036	<b>VCR</b>	FIDELITY	0027	
SEI	0543	TANDY	0120, 0190	ASA	0064, 0108	FINLANDIA	0108, 0131
SKY	0064	TASHIKO	0119, 0677	ADMIRAL	0075	FINLUX	0027, 0069, 0108, 0131
SSS	0207	TATUNG	0036, 0064, 0078, 0081, 0087, 0181, 0183, 0543	ADVENTURA	0027	FIRSTLINE	0064, 0070, 0072, 0099
SABA	0136, 0190, 0314, 0362	TEAC	0036, 0064, 0291, 0439, 0445, 0482, 0695, 1064	AIKO	0305	FISHER	0074, 0131
SACCS	0265	TEC	0274	AIWA	0027, 0064, 0334, 0375, 0379	FUJI	0060, 0062
SAGEM	0637	TECHNEMA	0347	AKAI	0068, 0342	FUJITSU	0027, 0072
SAISHO	0036, 0291, 0543	TECHNICS	0078, 0277, 0677	AKIBA	0099	FUNAI	0027
SALORA	0190, 0380, 0388, 0575	TECHWOOD	0078	ALBA	0099, 0305, 0342, 0379	GE	0062, 0087, 0267, 0834, 1062, 1087
SAMBERS	0543	TECO	0036, 0078, 0119, 0120, 0205, 0291, 0680	AMERICA ACTION	0305	GEC	0108
SAMPO	0036, 0057, 0119, 0120, 0181, 0198, 0205, 0677, 1782	TEKNIKA	0081, 0087, 0119, 0177, 0207	AMERICAN HIGH	0062	GARRARD	0027
SAMSUNG	0036, 0057, 0064, 0087, 0117, 0119, 0181, 0205, 0291, 0397, 0583, 0614, 0645, 0729, 0793, 0839, 0841	TELEFUNKEN	0136, 0289, 0362, 0652, 0729	AMSTRAD	0027	GENERAL	0072
SANSEI	0478	TELEMEISTER	0347	ANAM	0064, 0253, 0267, 0305, 0507	GO VIDEO	0459
SANSUI	0490	TELETECH	0036	ANAM NATIONAL	0253, 1589	GOLDHAND	0099
SANYO	0131, 0181, 0207, 0235, 0366, 0826	TENSAI	0347	ANITECH	0099	GOLDSTAR	0064, 0252, 0507, 1264
SCHAUB LORENZ	0388	TERA	0057	ASHA	0267	GOODMANS	0027, 0064, 0099, 0305
SCHNEIDER	0064, 0274, 0398, 0695	THOMSON	0136, 0314, 0587, 0652, 1474	ASHUKA	0064	GRADIENTE	0027
SCOTCH	0205	THORN	0064, 0131, 0388, 0539	AUDIOVOX	0064, 0305	GRAETZ	0068, 0131, 0267
SCOTT	0205, 0207, 0263	TOSHIBA	0087, 0181, 0183, 0535, 0645, 0677, 0859, 1283, 1383, 1683, 1731	BAIRD	0027, 0068, 0131	GRANADA	0108, 0131
SEARS	0074, 0081, 0181, 0183, 0198, 0205	TRIUMPH	0543	BASIC LINE	0099, 0305	GRANDIN	0027, 0064, 0099
SELECO	0190, 0286	TUNTEX	0036, 0057, 0119	BEAUMARK	0267	GRUNDIG	0099, 0108, 0253, 0374
SEMIVOX	0207	UHER	0347	BELL & HOWELL	0131	HCM	0099
SEMP	0183	UNIVERSUM	0064, 0131, 0132, 0291, 0373, 0397, 0519	BLAUPUNKT	0253	HI-Q	0074
SHARP	0057, 0120, 0677	VECTOR RESEARCH	0057	BRANDT	0347	HANSEATIC	0064
SHEN YING	0036, 0119	VESTEL	0064	BRANDT ELECTRONIC	0068	HARLEY DAVIDSON	0027
SHENG CHIA	0036, 0120, 0263	VICTOR	0080, 0277, 0677, 0680	BROKSONIC	0211, 0375, 1506	HARMAN/KARDON	0108
SIAREM	0543	VIDEOSAT	0274	BUSH	0099, 0305, 0379	HARWOOD	0099
SIEMENS	0064, 0222	VIDIKRON	0081	CCE	0099, 0305	HINARI	0099, 0267, 0379
SINUDYNE	0543	VIDTECH	0205	CGE	0027	HITACHI	0027, 0064, 0068, 0069, 0267
SKANTIC	0383	VIEWSONIC	1782	CALIX	0064	HUGHES NETWORK SYSTEMS	0069
SKYGIANT	0207	VISION	0347	CANON	0062	HYPSON	0099
SKYWORTH	0064	VOXSON	0190	CARVER	0108	ITT	0068, 0131, 0267
SOLAVOX	0190	WALTHAM	0383	CIMLINE	0099	ITV	0064, 0305
SONITRON	0235	WARDS	0057, 0081, 0205, 0893	CINERAL	0305	IMPERIAL	0027
SONOKO	0036, 0064	WAYCON	0183	CITIZEN	0064, 0305, 1305	INTERFUNK	0108
SONOLOR	0190, 0235	WHITE WESTINGHOUSE	0064, 0347, 0490, 0650	COLT	0099	JVC	0068, 0072, 0094
SONTEC	0064	YAMAHA	0057, 0172, 0677, 0796, 0860, 2900	COMBITECH	0379	JENSEN	0068
SONY	0027, 0677, 0861, 1127, 1532, 1678	ZENITH	0044, 0119, 0205, 0490	CRAIG	0064, 0074, 0099, 0267	KEC	0064, 0305
SOUNDESIGN	0205, 0207			CROWN	0099, 0305	KLH	0099
SOUNDWAVE	0064, 0445			CURTIS MATHES	0062, 0068, 0087, 1062	KAISUI	0099
SOWA	0078, 0087, 0119, 0183, 0205			CYBERNEX	0267	KENWOOD	0068, 0094
SQUAREVIEW	0198			CYRUS	0108	KODAK	0062, 0064
STANDARD	0036			DAEWOO	0072, 0131, 0305, 0669, 1305	KOLIN	0068, 0070
STARLITE	0207			DANSAI	0099	KORPEL	0099
STERN	0190, 0286			DE GRAAF	0069	LG	0064, 0069, 0072, 0507
SUPREME	0027			DECCA	0027, 0108	LXI	0064
SYLVANIA	0057, 0081, 0198			DENON	0069	LENCO	0305
SYMPHONIC	0198, 0207			DUAL	0068	LEYCO	0099
SYNCO	0027, 0087, 0119, 0120, 0205, 0478			DUMONT	0027, 0108, 0131	LLOYD'S	0027
SYSLINE	0064			DYNATECH	0027	LOEWE	0064, 0108, 1589
T + A	0474			ESC	0267, 0305	LOGIK	0099, 0267
TCM	0835			ELCATECH	0099	LUXOR	0070, 0075, 0131
TMK	0205			ELECTROHOME	0064	M ELECTRONIC	0027
TNCI	0044			ELECTROPHONIC	0064	MEI	0062
TVS	0490			EMEREX	0059	MGA	0070, 0267
TACICO	0036, 0119, 0205			EMERSON	0027, 0062, 0064, 0070, 0072, 0211, 0267, 0305, 1305, 1506	MGN TECHNOLOGY	0267
				FERGUSON	0068, 0347	MAGNASONIC	1305
						MAGNAVOX	0027, 0062, 0066, 0108, 1808
						MAGNIN	0267

MANESTH	0072, 0099	PANASONIC	0062, 0252, 0253, 0643, 1062, 1589	SABA	0068, 0347	TECHNICS	0062, 0253
MARANTZ	0062, 0108	PATHE MARCONI	0068	SALORA	0070	TECO	0062, 0064, 0068, 0075
MARTA	0064	PENNEY	0062, 0064, 0069, 0267, 1062, 1264	SAMPO	0064, 0075	TEKNIKA	0027, 0062, 0064
MATSUI	0375, 0379	PENTAX	0069	SAMSUNG	0072, 0267, 0459	TELEAVIA	0068
MATSUSHITA	0062	PERDIO	0027	SANKY	0066, 0075	TELEFUNKEN	0068, 0347
MEDION	0375	PHILCO	0062	SANSUI	0027, 0068, 0094, 1506	TENOSAL	0099
MEMOREX	0027, 0062, 0064, 0066, 0074, 0075, 0131, 0267, 0334, 0375, 1264	PHILIPS	0062, 0108, 0645, 1108, 1208	SANYO	0074, 0131, 0267	TENSAI	0027
MEMPHIS	0099	PHONOLA	0108	SAVILLE	0379	THOMAS	0027
METZ	0064, 0374, 1589	PILOT	0064	SCHAUB LORENZ	0027, 0068, 0131	THOMSON	0068, 0087, 0094, 0347
MINOLTA	0069	PIONEER	0069, 0094, 0108	SCHNEIDER	0027, 0099, 0108	THORN	0068, 0131
MITSUBISHI	0068, 0070, 0094, 0108, 0834	POLK AUDIO	0108	SCOTT	0070, 0072, 0211	TIVO	0645, 0663
MOTOROLA	0062, 0075	PROFITRONIC	0267	SEARS	0027, 0062, 0064, 0069, 0074, 0131, 1264	TOSHIBA	0068, 0070, 0072, 0094, 0108, 0872
MULTITECH	0027, 0099	PROLINE	0027	SELECO	0068	TOTEVISION	0064, 0267
MURPHY	0027	PROSCAN	0087, 1087	SEMP	0072	UNITECH	0267
MYRYAD	0108	PROTEC	0099	SHARP	0075, 0834	UNIVERSUM	0027, 0064, 0108, 0267
NAD	0131	PULSAR	0066	SHINTOM	0099, 0131	VECTOR	0072
NEC	0062, 0064, 0068, 0075, 0094, 0131	PYE	0108	SIEMENS	0064, 0108, 0131	VICTOR	0068, 0094
NATIONAL	0253	QUASAR	0062, 1062	SILVA	0064	VIDEO CONCEPTS	0072
NECKERMANN	0108	QUELLE	0108	SINGER	0072, 0099	VIDEOMAGIC	0064
NESCO	0099	RCA	0062, 0069, 0087, 0267, 0834, 1062, 1087	SINUDYNE	0108	VIDEOSONIC	0267
NEWAVE	0064	RADIO SHACK	0027	SONIC BLUE	0641, 0643	VILLAIN	0027
NIKKO	0064	RADIOLA	0108	SONTEC	0064	WARDS	0027, 0062, 0069, 0074, 0075, 0087, 0099, 0108, 0267
NOBLEX	0267	RADIX	0064	SONY	0027, 0059, 0060, 0062, 0663, 1259	WHITE WESTINGHOUSE	0099
NOKIA	0068, 0131, 0267	RANDEX	0064	SUNKAI	0375	XR-1000	0027, 0062, 0099
NORDMENDE	0068, 0347	REALISTIC	0027, 0062, 0064, 0074, 0075, 0131	SUNSTAR	0027	YAMAHA	0068
OCEANIC	0027, 0068	REOC	0375	SUNTRONIC	0027	YAMISHI	0099
OKANO	0342, 0375	REPLAYTV	0641, 0643	SYLVANIA	0027, 0062, 0108, 0070, 1808	YOKAN	0099
OLYMPUS	0062, 0253	REX	0068	SYMPHONIC	0027	YOKO	0267
OPTIMUS	0064, 0075, 0131, 0459	ROADSTAR	0064, 0099, 0267, 0305	TMK	0267	ZENITH	0027, 0060, 0066, 1506
ORION	0211, 0375, 0379, 1506	RUNCO	0066	TANDY	0027, 0131		
OSAKI	0027, 0064, 0099	SBR	0108	TASHIKO	0027, 0064		
OTTO VERSAND	0108	SEG	0267	TATUNG	0027, 0068, 0072, 0094, 0108		
PALLADIUM	0064, 0068, 0099	SEI	0108	TEAC	0027, 0068, 0305, 0334, 0669		
		STS	0069				



© 2008 YAMAHA CORPORATION All rights reserved.

YAMAHA ELECTRONICS CORPORATION, USA 6660 ORANGETHORPE AVE., BUENA PARK, CALIF. 90620, U.S.A.  
 YAMAHA CANADA MUSIC LTD. 135 MILNER AVE., SCARBOROUGH, ONTARIO M1S 3R1, CANADA  
 YAMAHA ELECTRONIK EUROPA G.m.b.H. SIEMENSSTR. 22-34, 25462 RELLINGEN BEI HAMBURG, GERMANY  
 YAMAHA ELECTRONIQUE FRANCE S.A. RUE AMBROISE CROIZAT BP70 CROISSY-BEAUBOURG 77312 MARNE-LA-VALLEE CEDEX02. FRANCE  
 YAMAHA ELECTRONICS (UK) LTD. YAMAHA HOUSE, 200 RICKMANSWORTH ROAD WATFORD, HERTS WD18 7GQ, ENGLAND  
 YAMAHA SCANDINAVIA A.B. J A WETTERGRENS GATA 1, BOX 30053, 400 43 VÄSTRA FRÖLUNDA, SWEDEN  
 YAMAHA MUSIC AUSTRALIA PTY. LTD. LEVEL 1, 99 QUEENSBRIDGE STREET, SOUTHBANK, VIC 3006, AUSTRALIA

YAMAHA CORPORATION  
 Printed in Malaysia ☞ WN24880

The circled numbers and alphabets correspond to those in the Owner's Manual.

## ■ Front panel

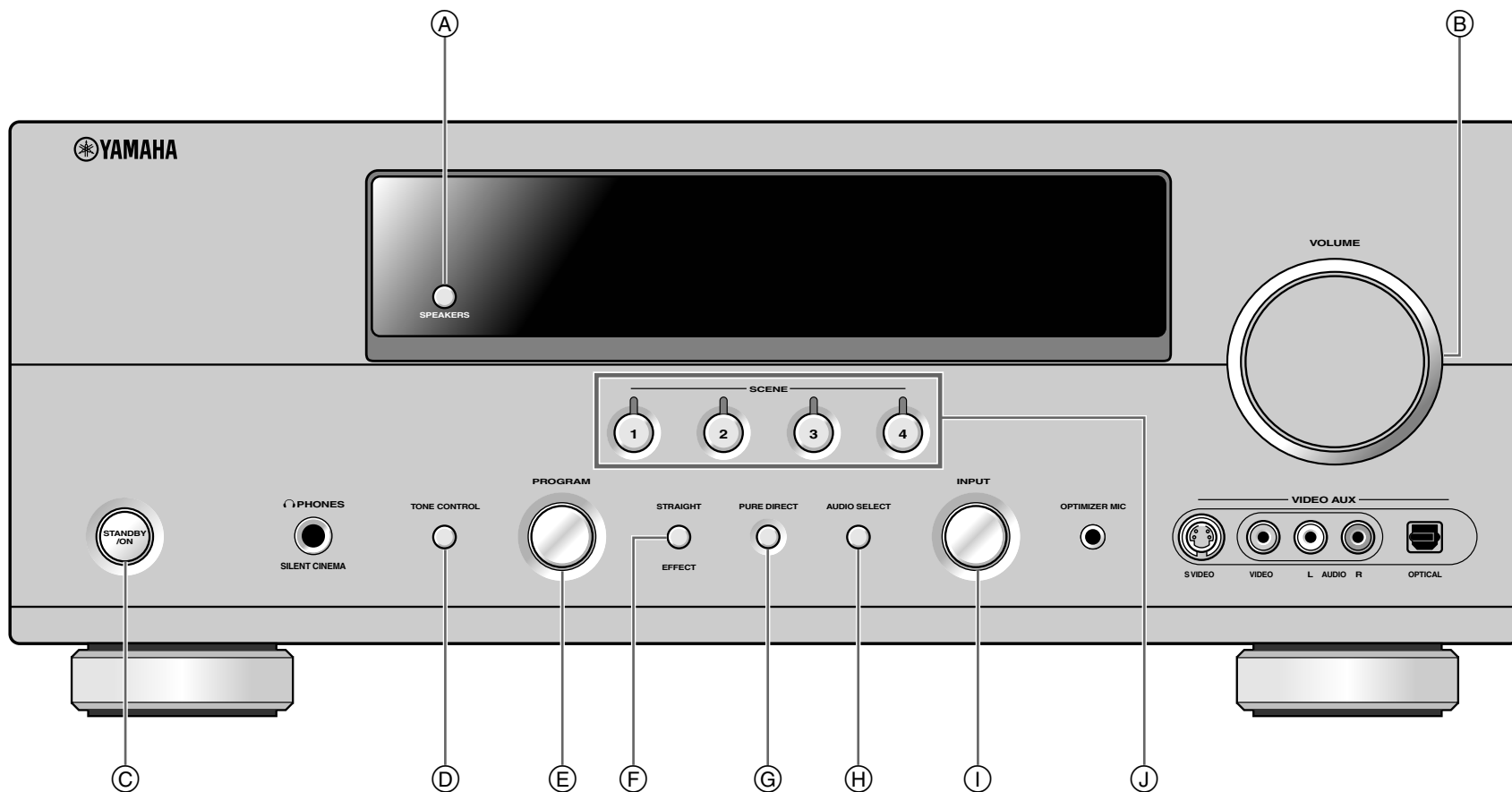

# Remote control

